

Velika logična pošast

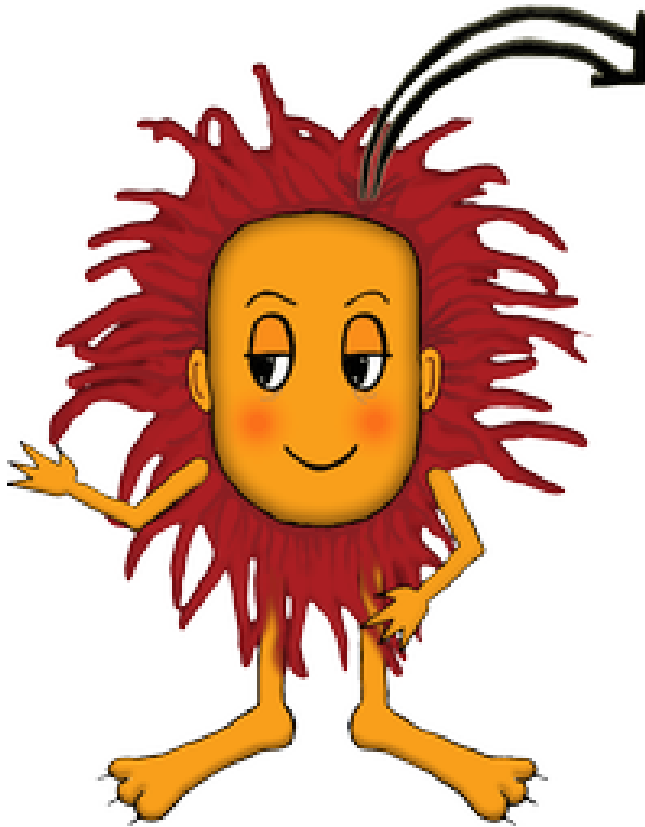

Enačbe premic skozi pare točk

Dane so točke A, B, C, \dots
Zapiši enačbe premic, ki gredo skozi pare:
 AB, AC, \dots, BC, \dots

1.

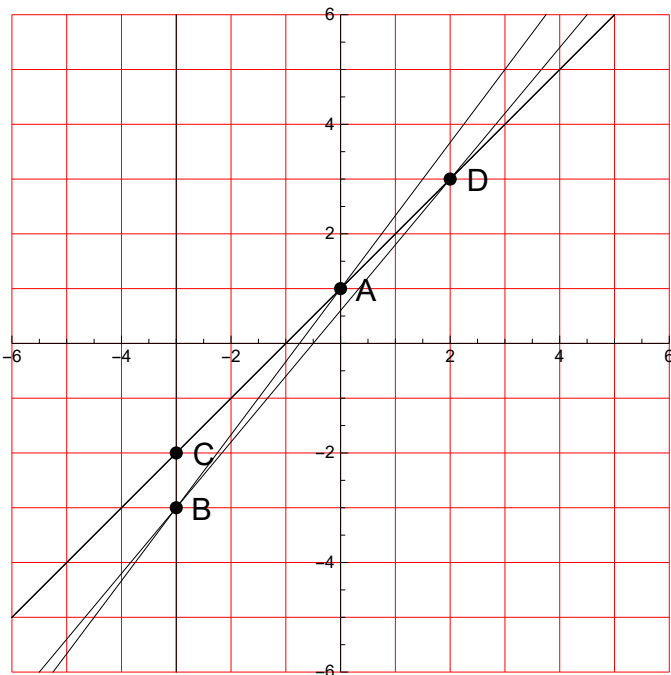

2.

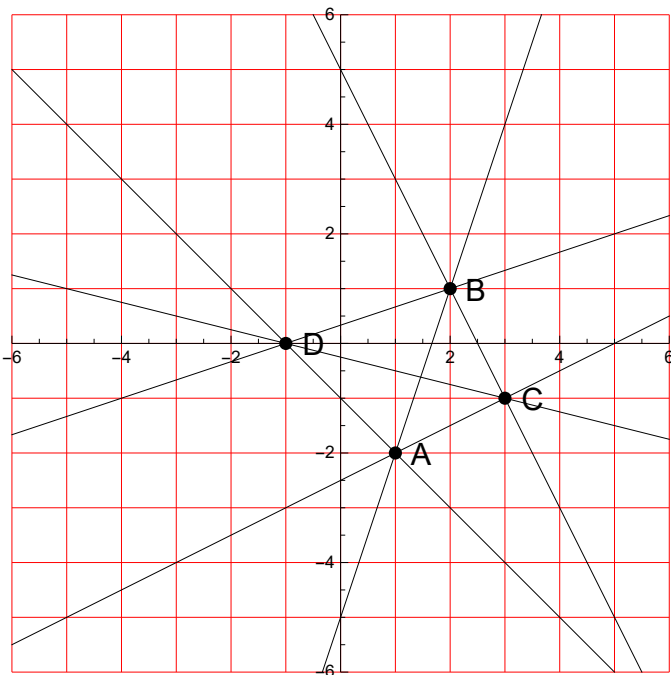

3.

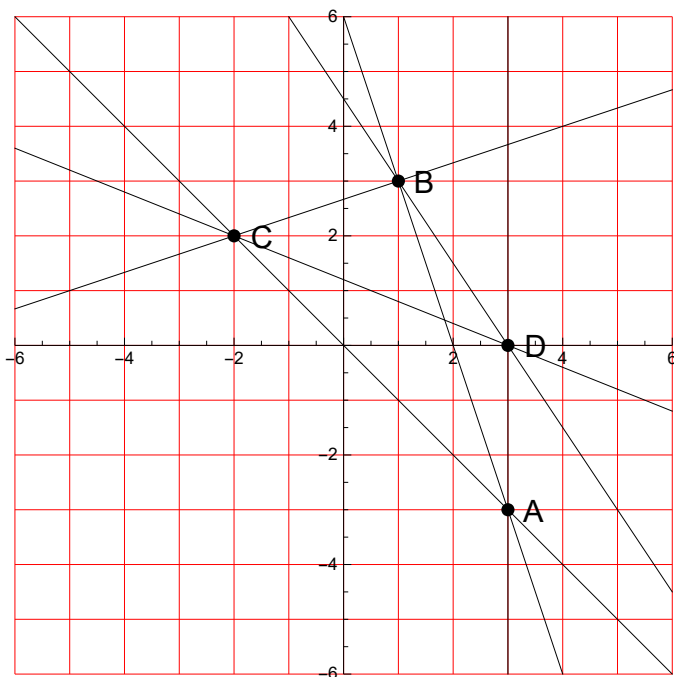

4.

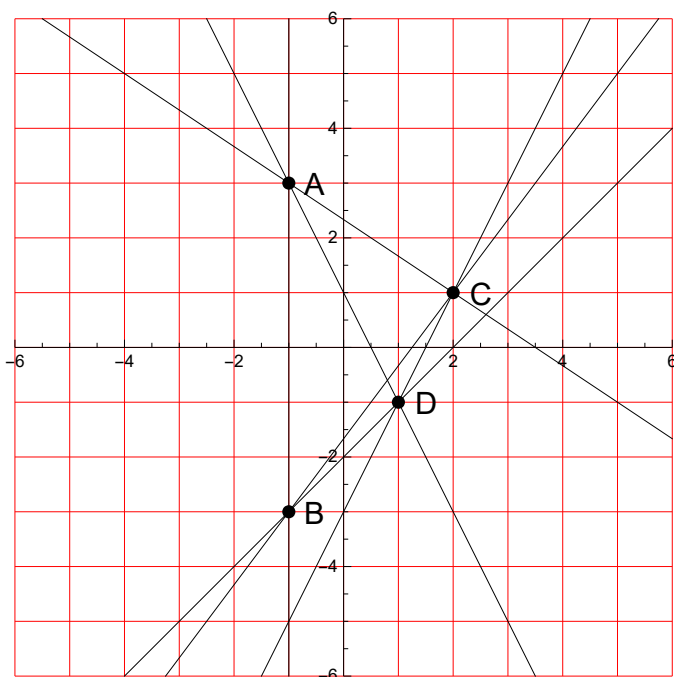

5.

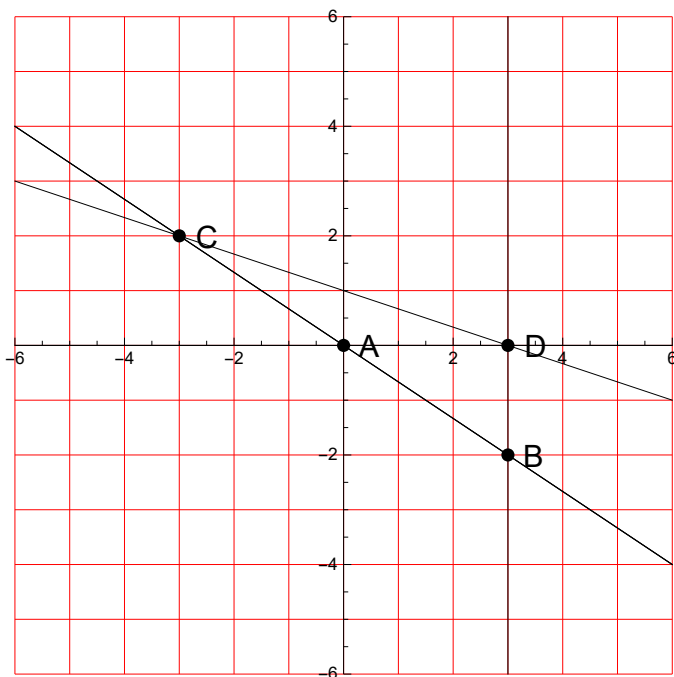

6.

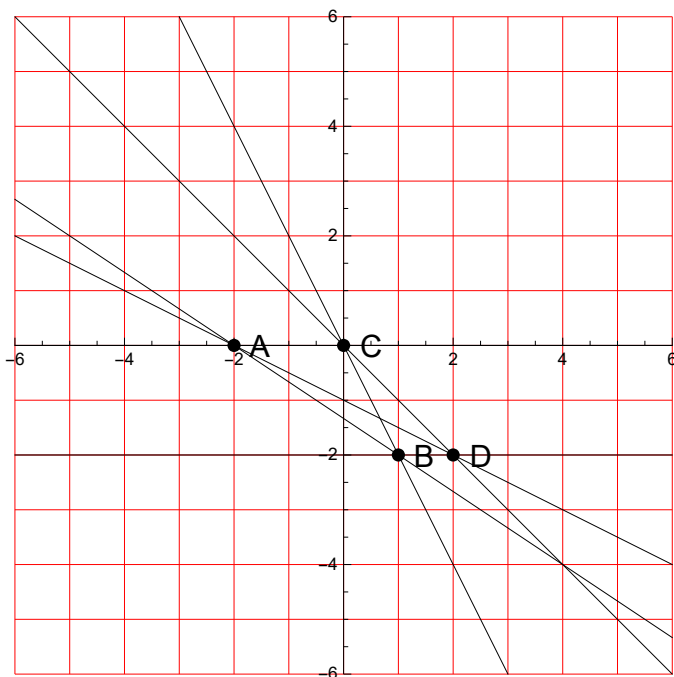

7.

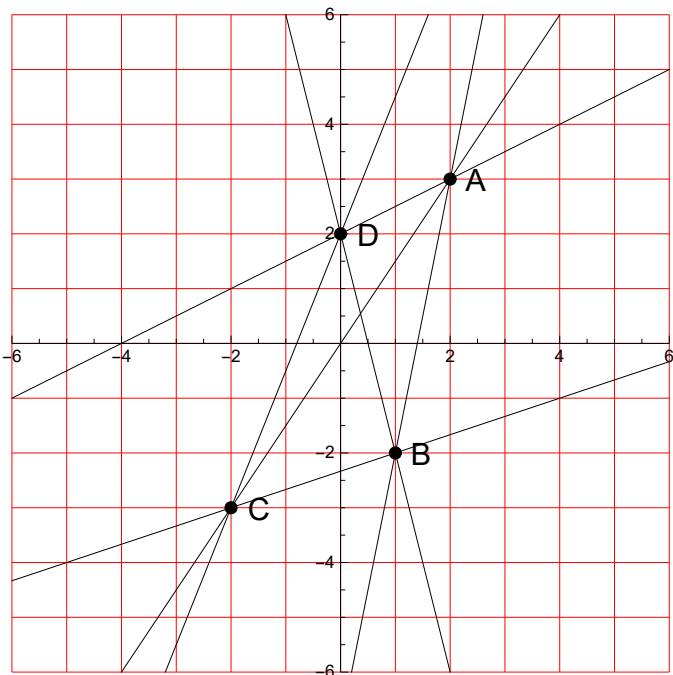

8.

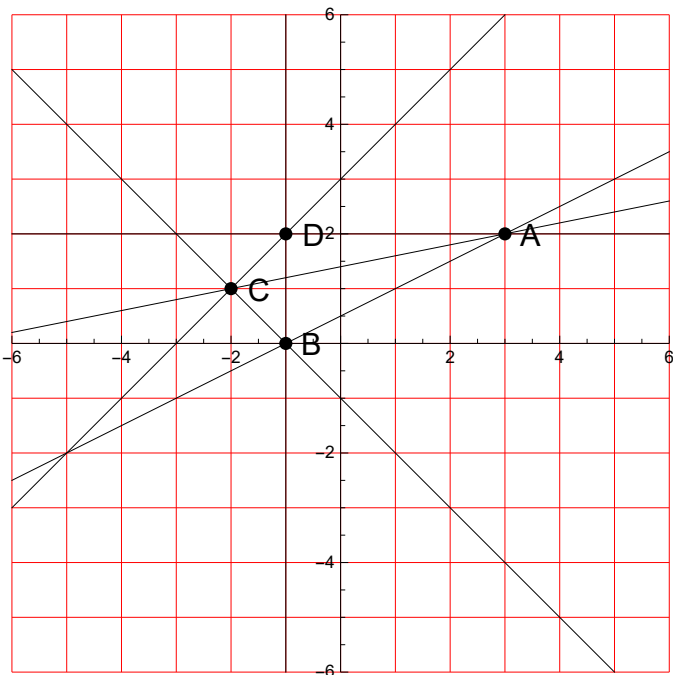

9.

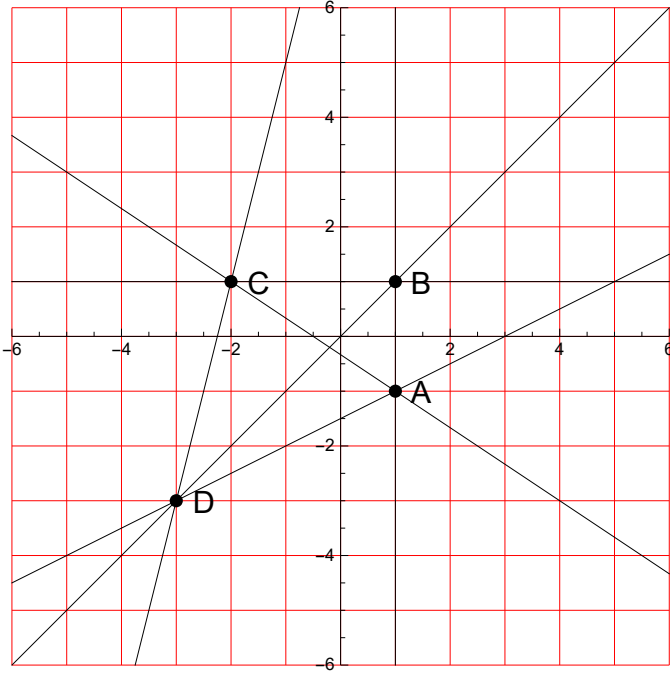

10.

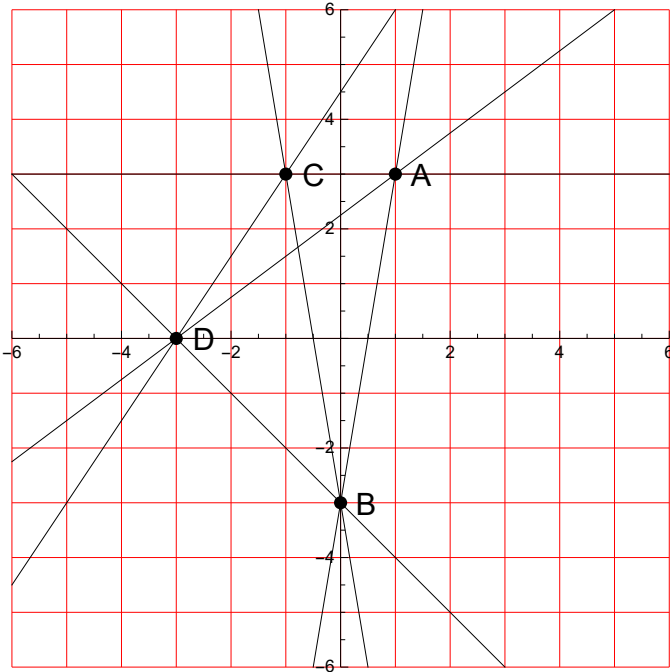

11.

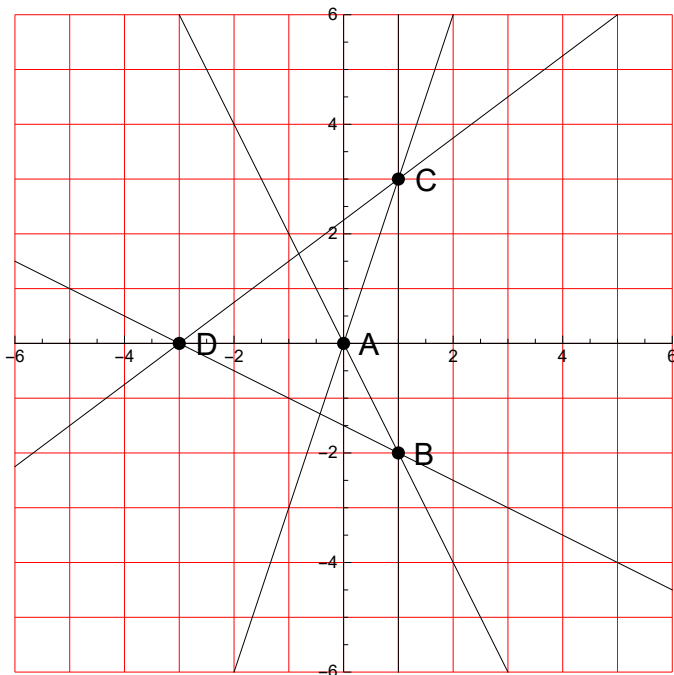

12.

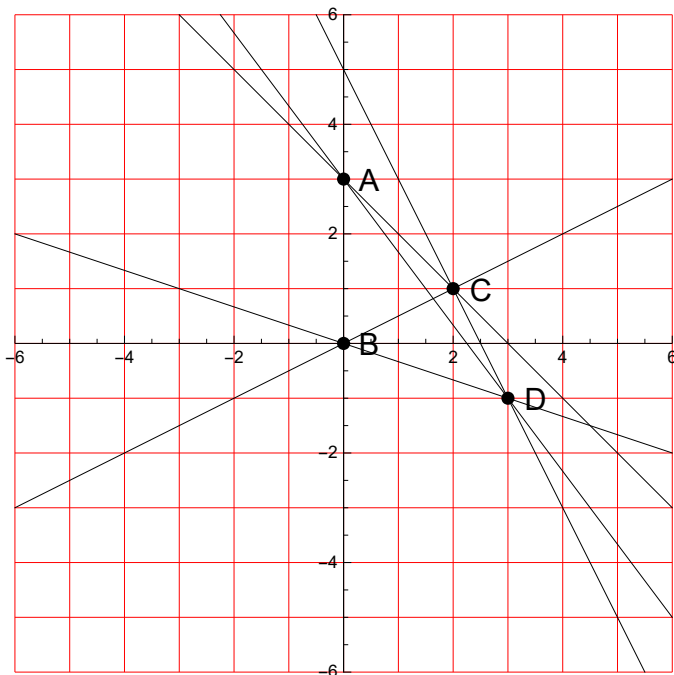

13.

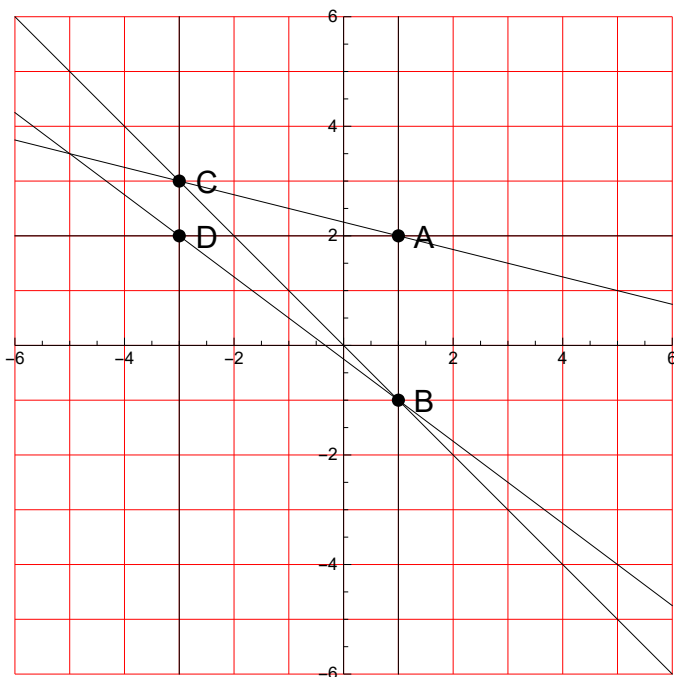

14.

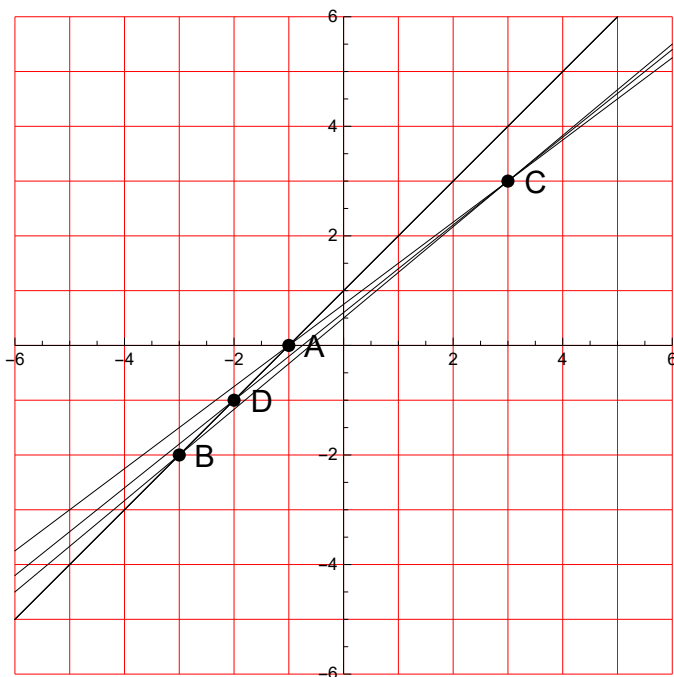

15.

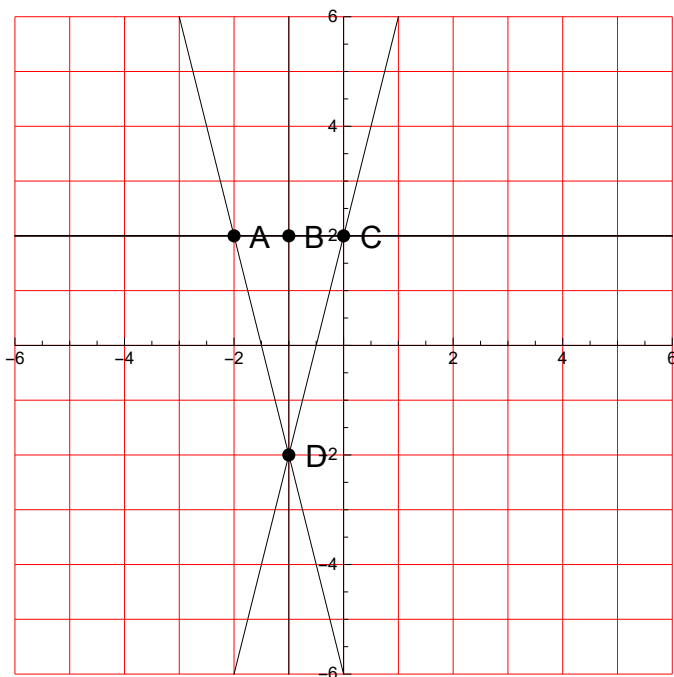

16.

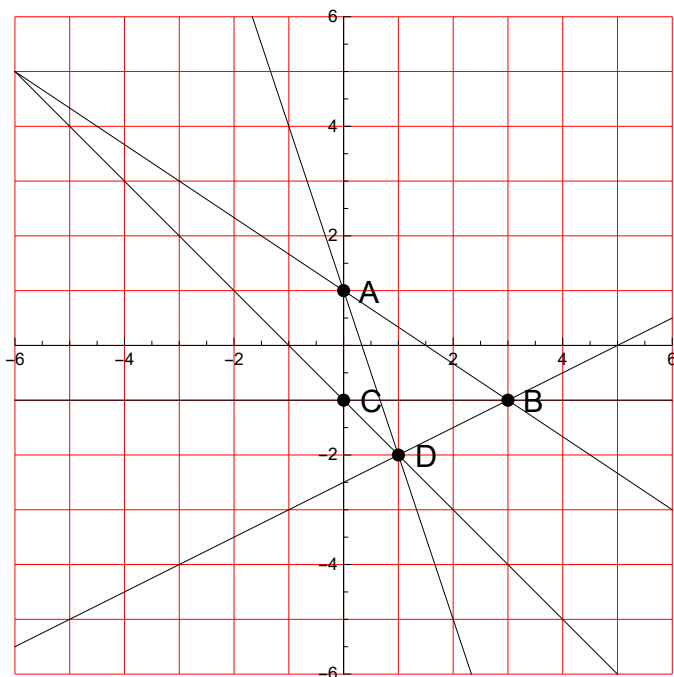

17.

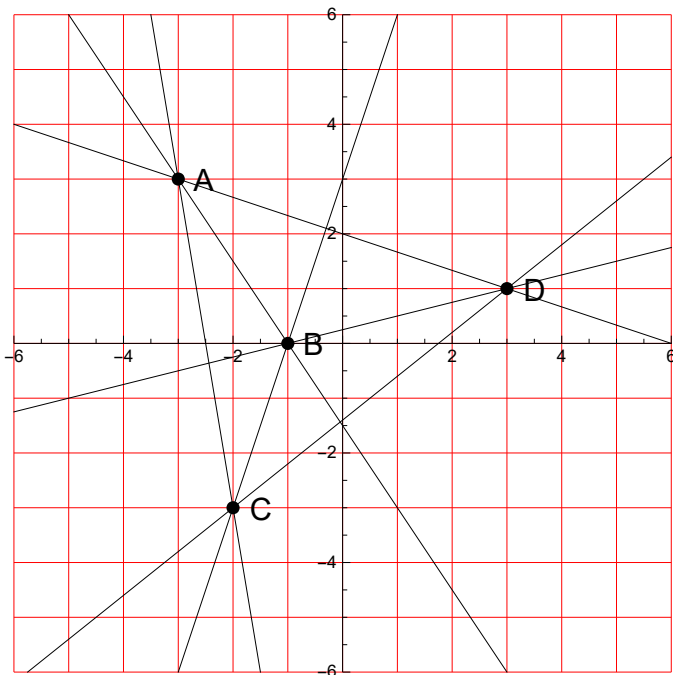

18.

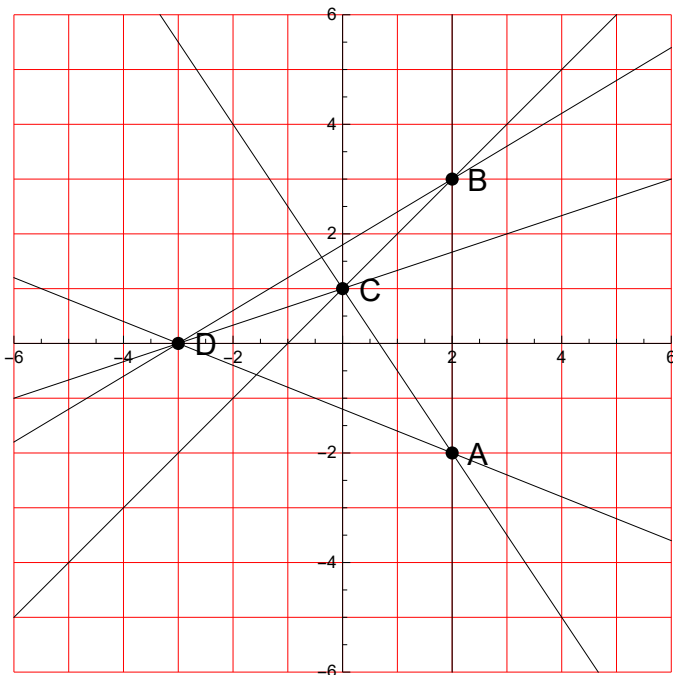

19.

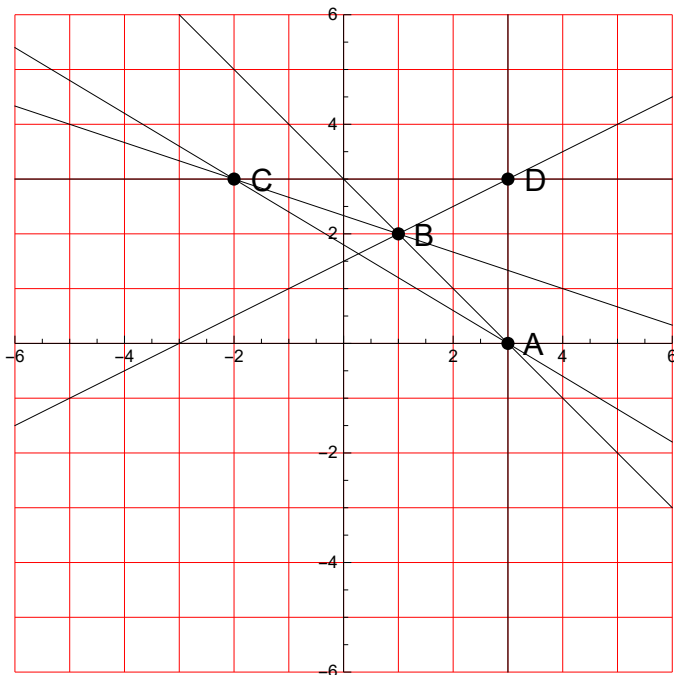

20.

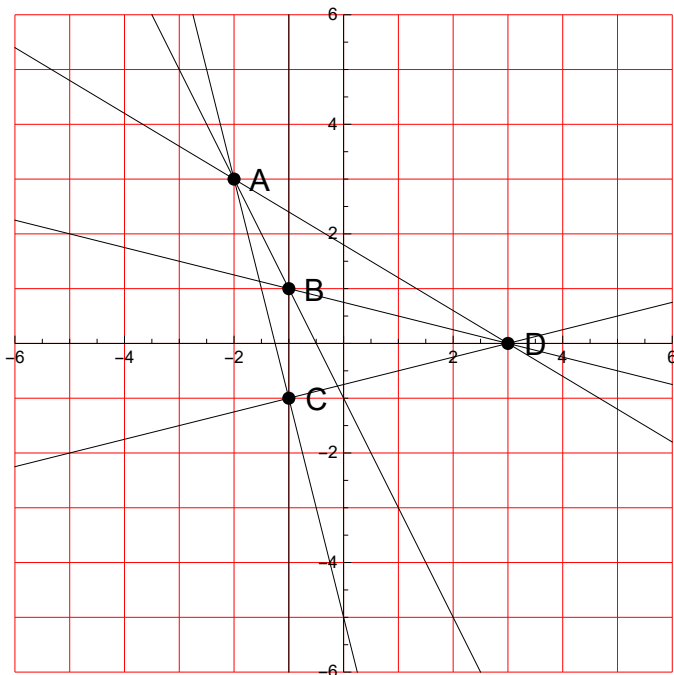

21.

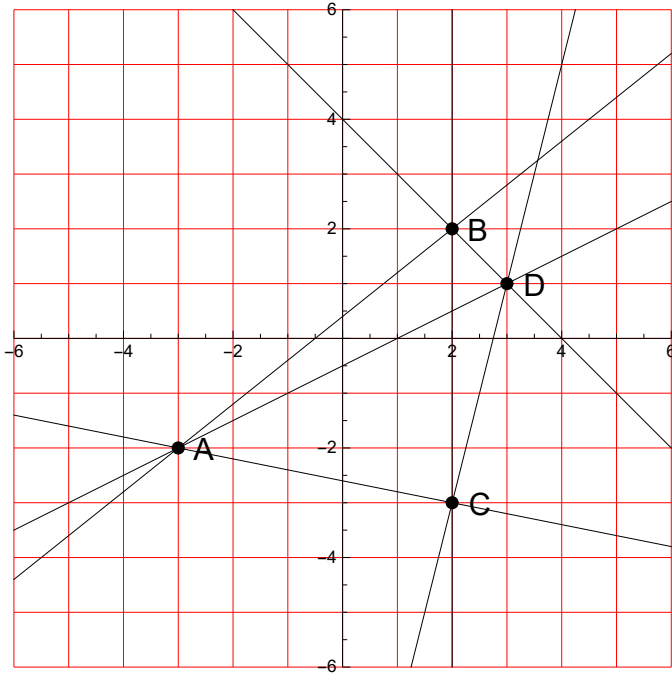

22.

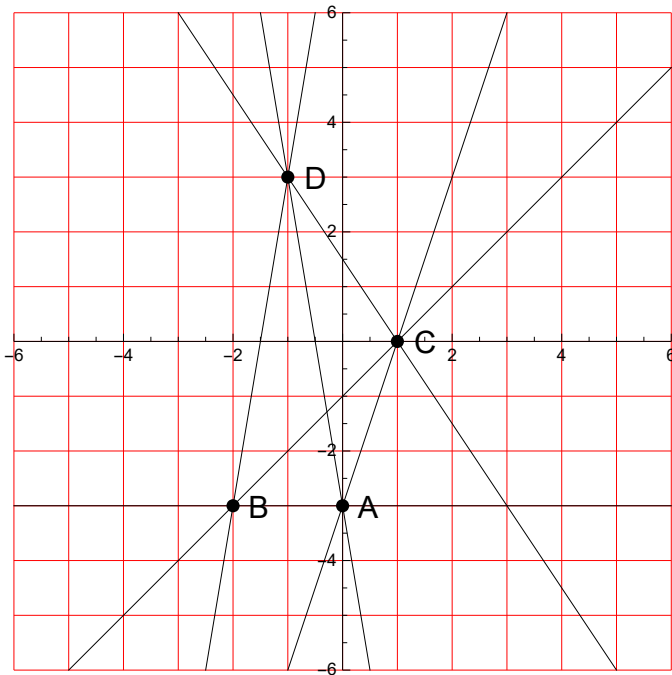

23.

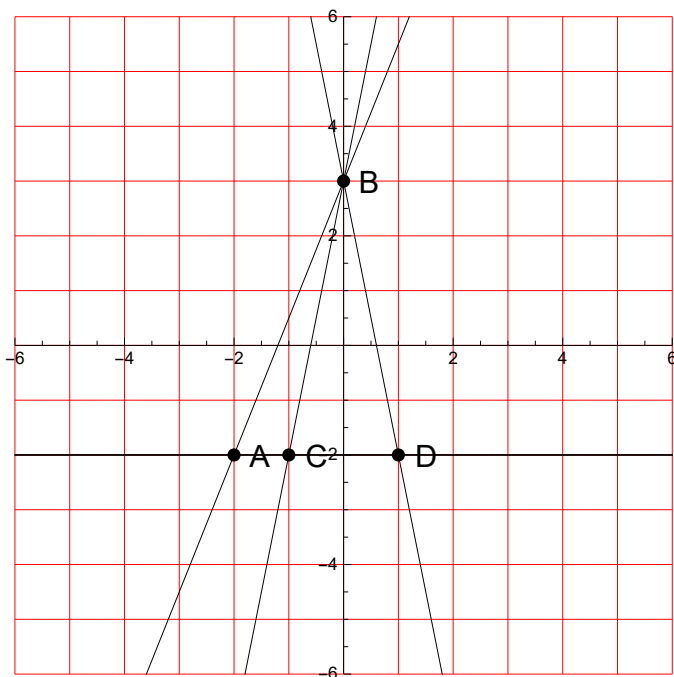

24.

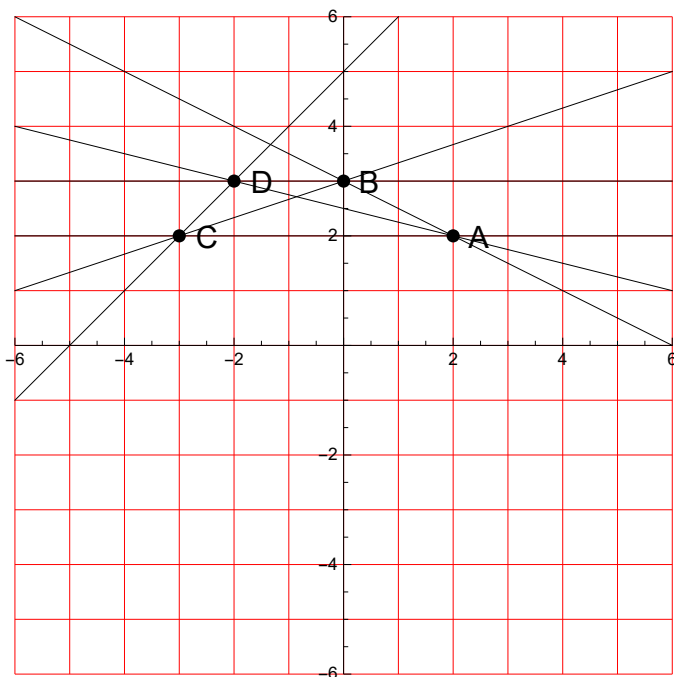

25.

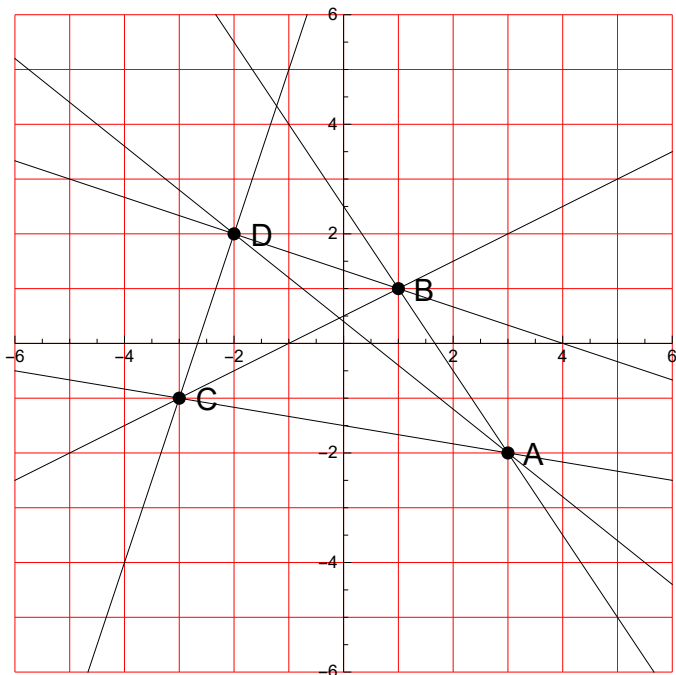

26.

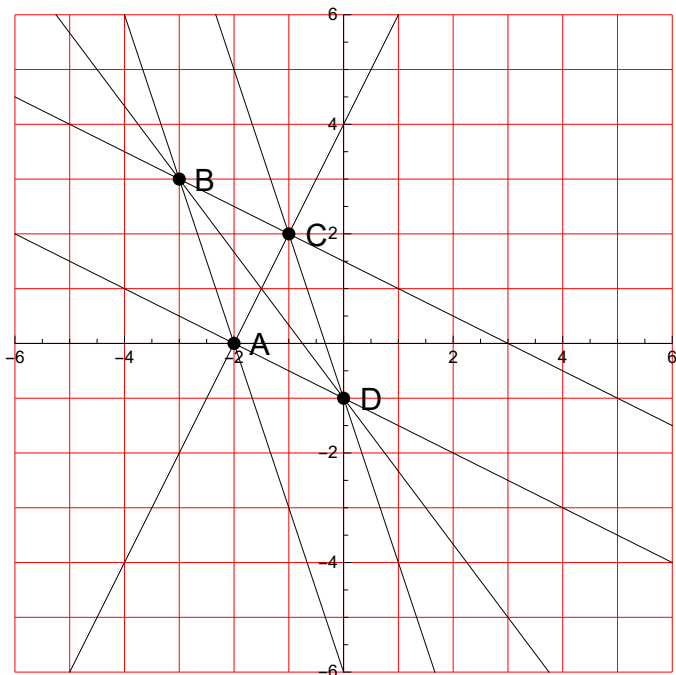

27.

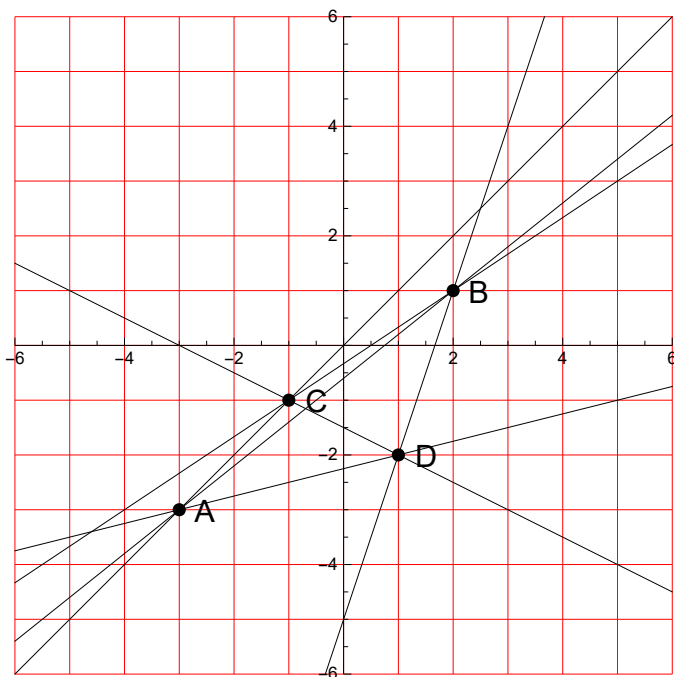

28.

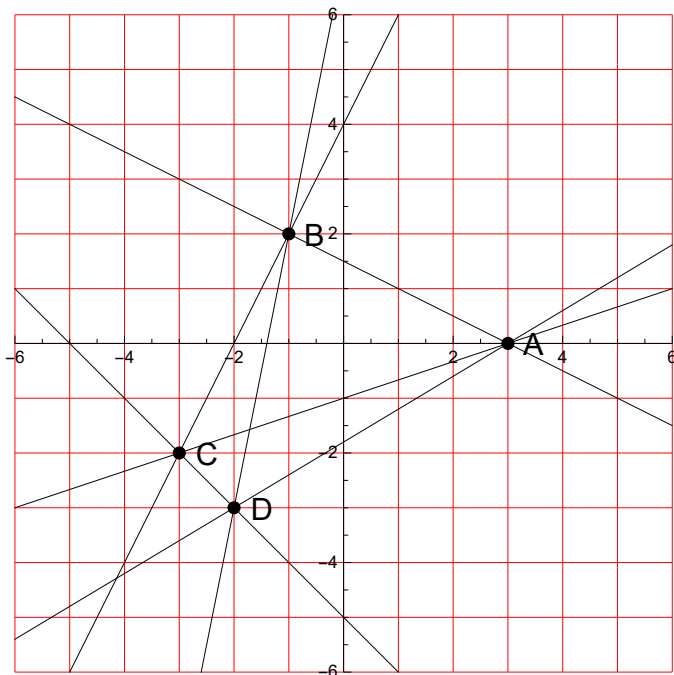

29.

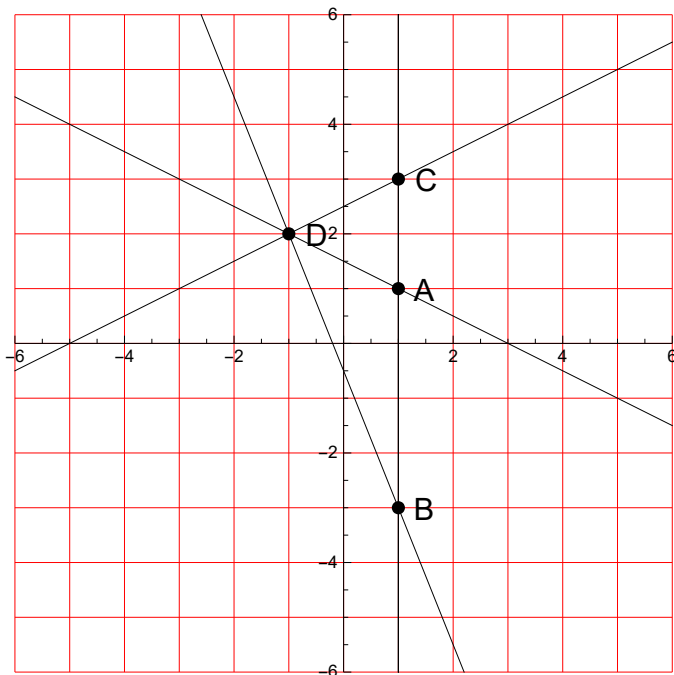

30.

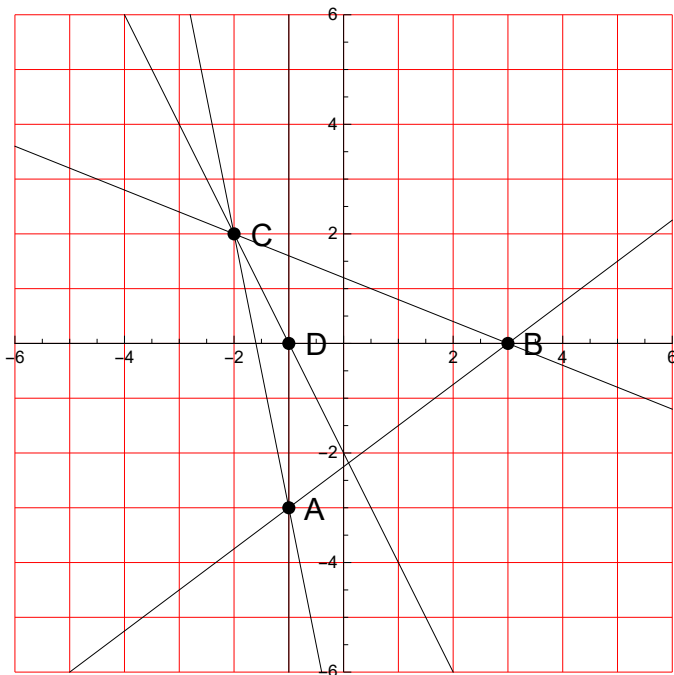

Rešitve:

1.

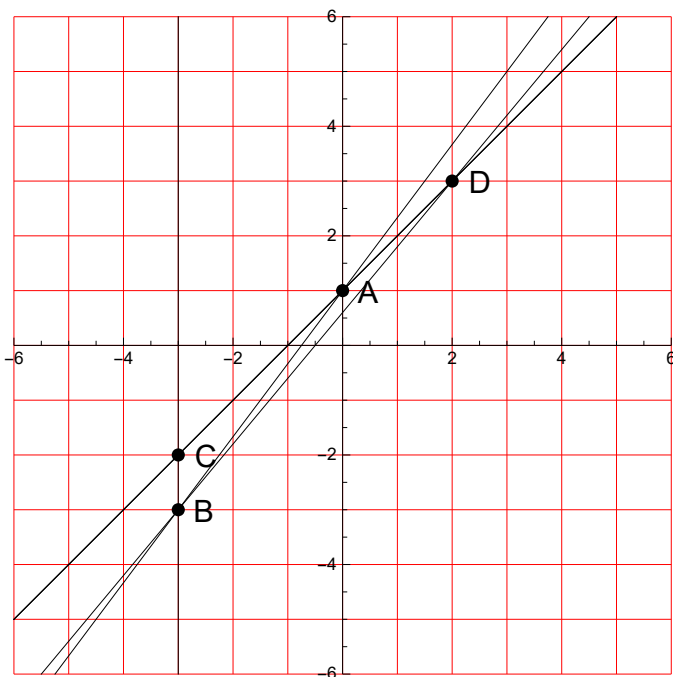

$$\begin{aligned} AB: y &= \frac{4x}{3} + 1 \\ AC: y &= x + 1 \\ AD: y &= x + 1 \\ BC: x &= -3 \\ BD: y &= \frac{6x}{5} + \frac{3}{5} \\ CD: y &= x + 1 \end{aligned}$$

2.

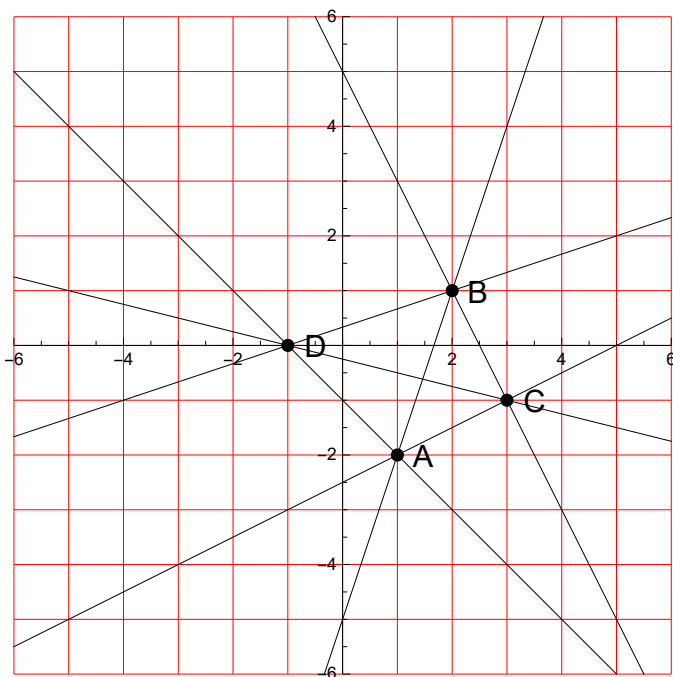

$$\begin{aligned} AB: y &= 3x - 5 \\ AC: y &= \frac{x}{2} - \frac{5}{2} \\ AD: y &= -x - 1 \\ BC: y &= 5 - 2x \\ BD: y &= \frac{x}{3} + \frac{1}{3} \\ CD: y &= -\frac{x}{4} - \frac{1}{4} \end{aligned}$$

3.

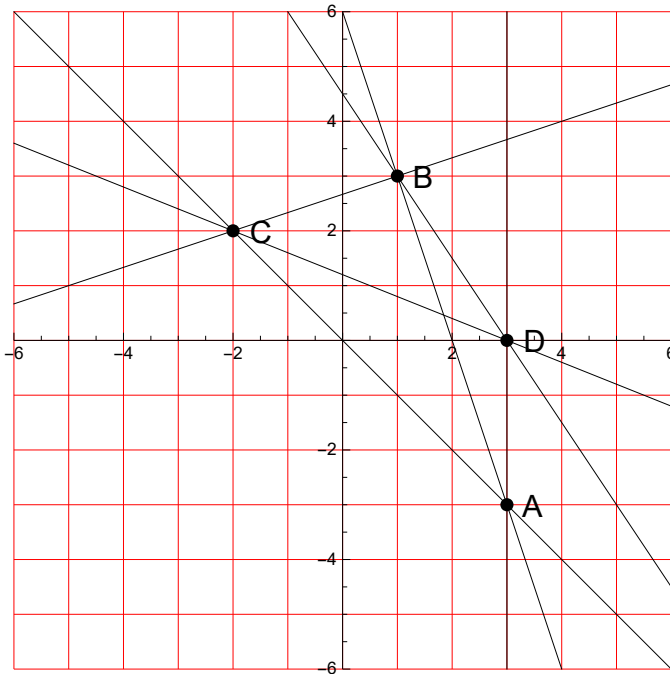

$$\begin{aligned} AB: y &= 6 - 3x \\ AC: y &= -x \\ AD: x &= 3 \\ BC: y &= \frac{x}{3} + \frac{8}{3} \\ BD: y &= \frac{9}{2} - \frac{3x}{2} \\ CD: y &= \frac{6}{5} - \frac{2x}{5} \end{aligned}$$

4.

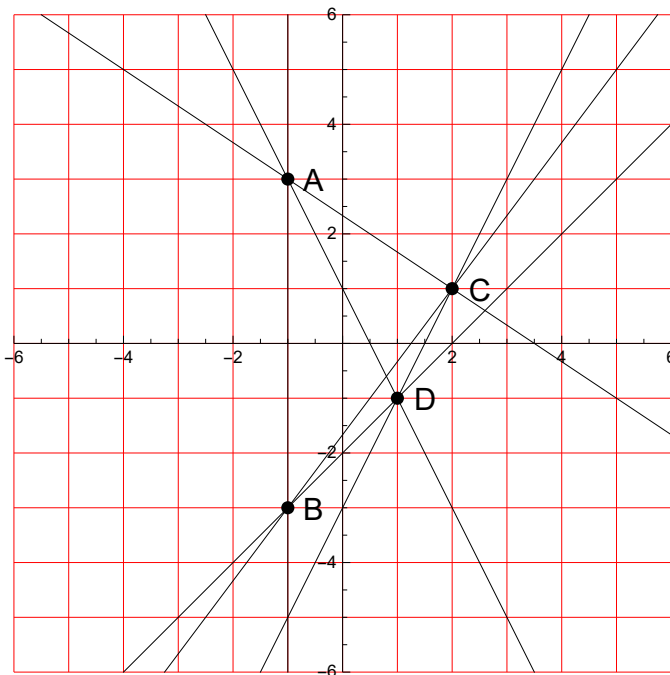

$$\begin{aligned} AB: x &= -1 \\ AC: y &= \frac{7}{3} - \frac{2x}{3} \\ AD: y &= 1 - 2x \\ BC: y &= \frac{4x}{3} - \frac{5}{3} \\ BD: y &= x - 2 \\ CD: y &= 2x - 3 \end{aligned}$$

5.

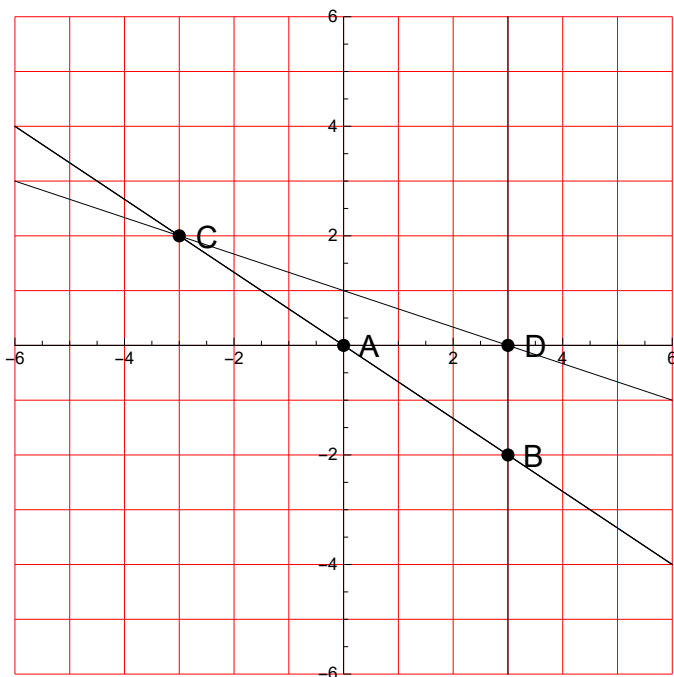

$$\begin{aligned}
 AB: y &= -\frac{2x}{3} \\
 AC: y &= -\frac{2x}{3} \\
 AD: y &= 0 \\
 BC: y &= -\frac{2x}{3} \\
 BD: x &= 3 \\
 CD: y &= 1 - \frac{x}{3}
 \end{aligned}$$

6.

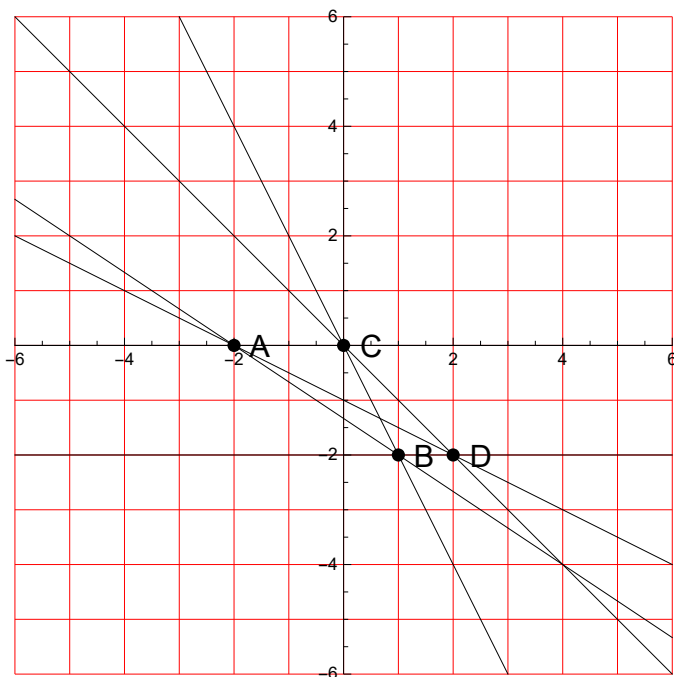

$$\begin{aligned}
 AB: y &= -\frac{2x}{3} - \frac{4}{3} \\
 AC: y &= 0 \\
 AD: y &= -\frac{x}{2} - 1 \\
 BC: y &= -2x \\
 BD: y &= -2 \\
 CD: y &= -x
 \end{aligned}$$

7.

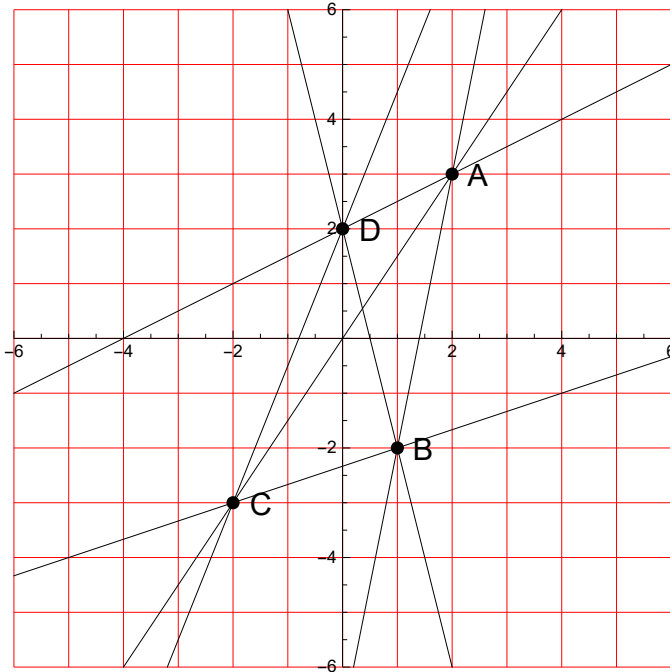

$$AB: y = 5x - 7$$

$$AC: y = \frac{3x}{2}$$

$$AD: y = \frac{x}{2} + 2$$

$$BC: y = \frac{x}{3} - \frac{7}{3}$$

$$BD: y = 2 - 4x$$

$$CD: y = \frac{5x}{2} + 2$$

8.

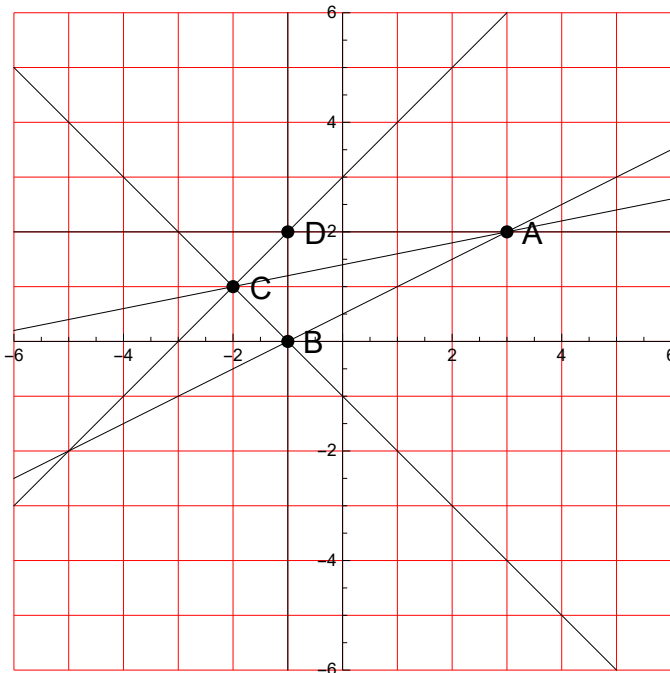

$$AB: y = \frac{x}{2} + \frac{1}{2}$$

$$AC: y = \frac{x}{5} + \frac{7}{5}$$

$$AD: y = 2$$

$$BC: y = -x - 1$$

$$BD: x = -1$$

$$CD: y = x + 3$$

9.

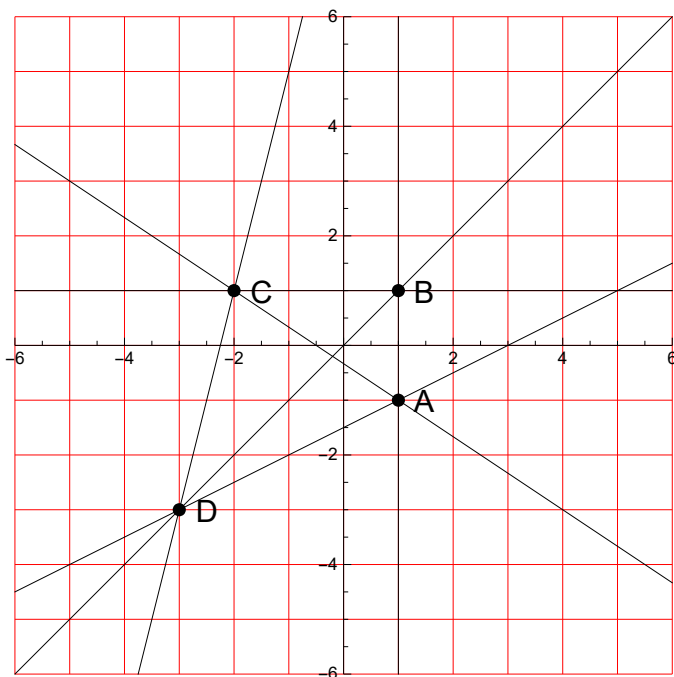

$$\begin{aligned} AB: & x = 1 \\ AC: & y = -\frac{2x}{3} - \frac{1}{3} \\ AD: & y = \frac{x}{2} - \frac{3}{2} \\ BC: & y = 1 \\ BD: & y = x \\ CD: & y = 4x + 9 \end{aligned}$$

10.

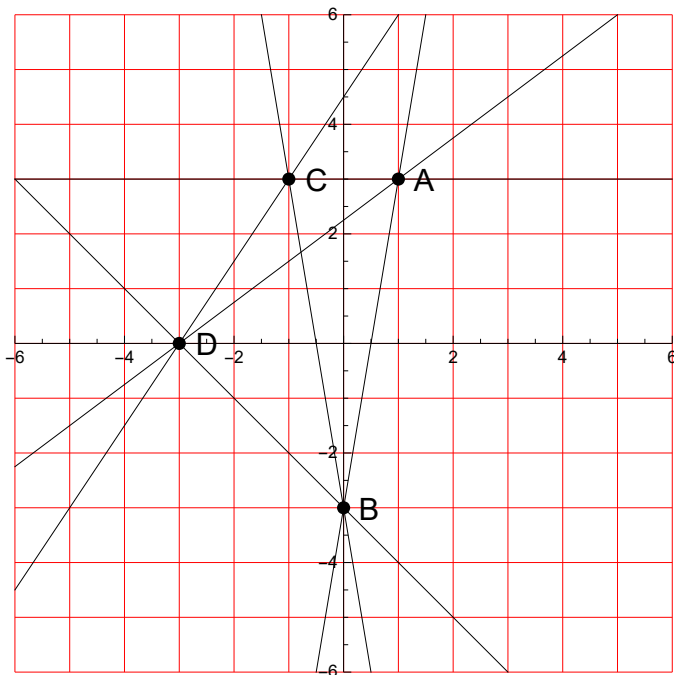

$$\begin{aligned} AB: & y = 6x - 3 \\ AC: & y = 3 \\ AD: & y = \frac{3x}{4} + \frac{9}{4} \\ BC: & y = -6x - 3 \\ BD: & y = -x - 3 \\ CD: & y = \frac{3x}{2} + \frac{9}{2} \end{aligned}$$

11.

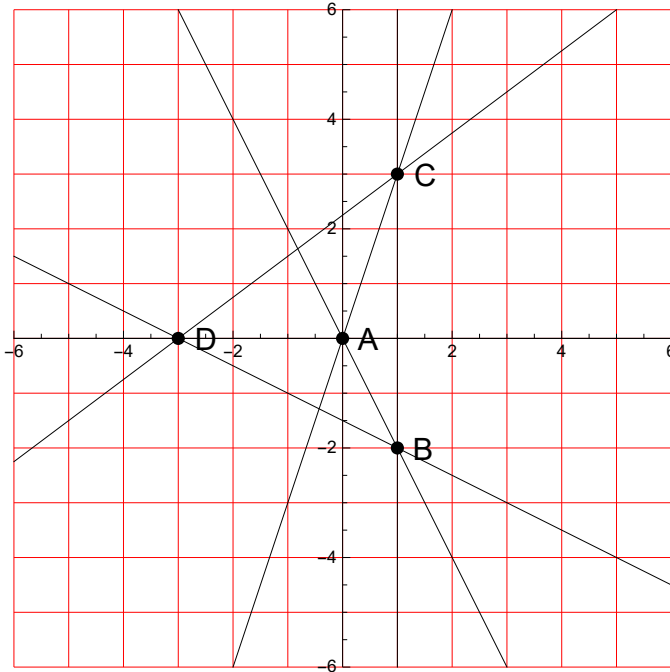

$$AB: y = -2x$$

$$AC: y = 3x$$

$$AD: y = 0$$

$$BC: x = 1$$

$$BD: y = -\frac{x}{2} - \frac{3}{2}$$

$$CD: y = \frac{3x}{4} + \frac{9}{4}$$

12.

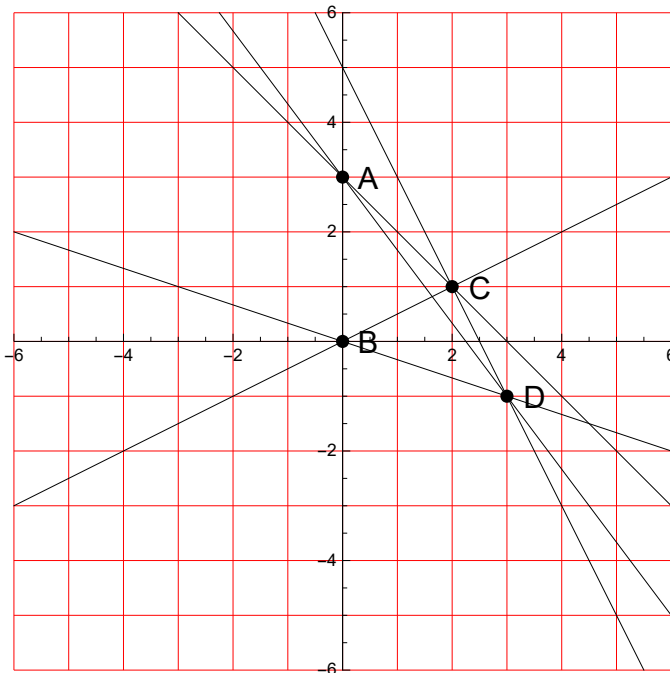

$$AB: x = 0$$

$$AC: y = 3 - x$$

$$AD: y = 3 - \frac{4x}{3}$$

$$BC: y = \frac{x}{2}$$

$$BD: y = -\frac{x}{3}$$

$$CD: y = 5 - 2x$$

13.

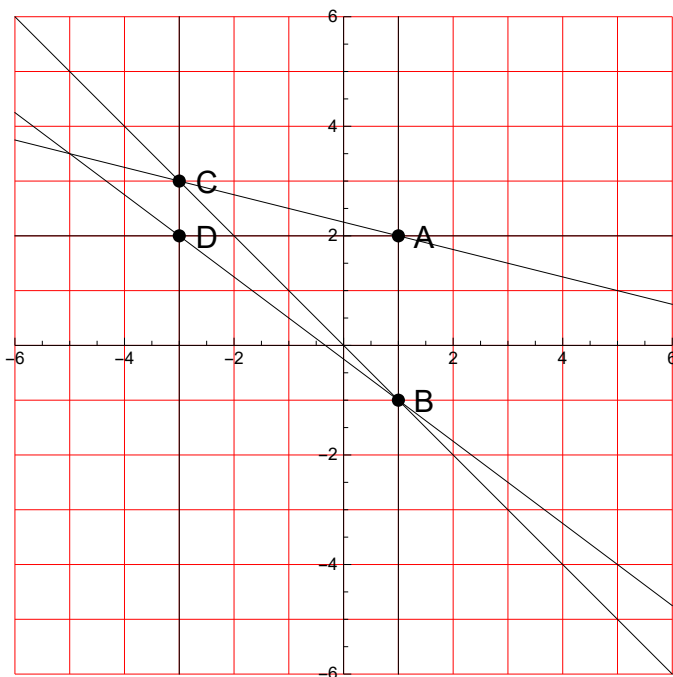

$$\begin{aligned} AB: x &= 1 \\ AC: y &= \frac{9}{4} - \frac{x}{4} \\ AD: y &= 2 \\ BC: y &= -x \\ BD: y &= -\frac{3x}{4} - \frac{1}{4} \\ CD: x &= -3 \end{aligned}$$

14.

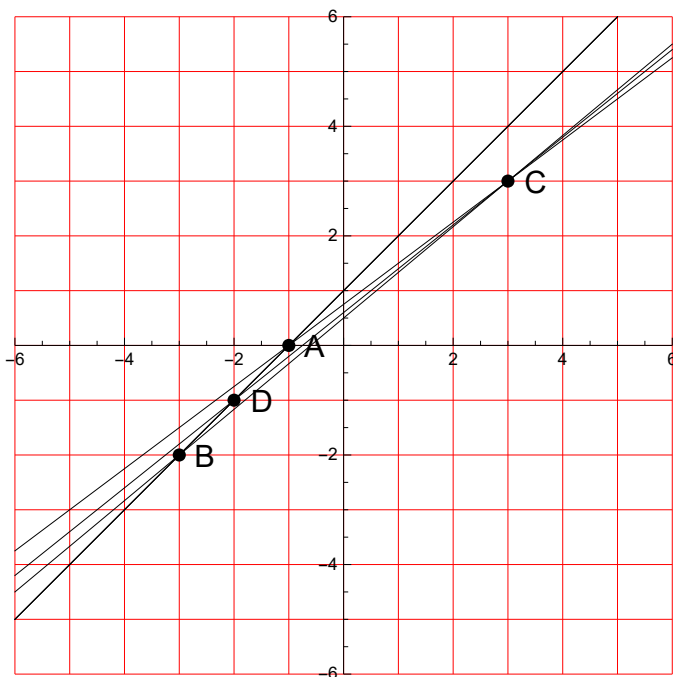

$$\begin{aligned} AB: y &= x + 1 \\ AC: y &= \frac{3x}{4} + \frac{3}{4} \\ AD: y &= x + 1 \\ BC: y &= \frac{5x}{6} + \frac{1}{2} \\ BD: y &= x + 1 \\ CD: y &= \frac{4x}{5} + \frac{3}{5} \end{aligned}$$

15.

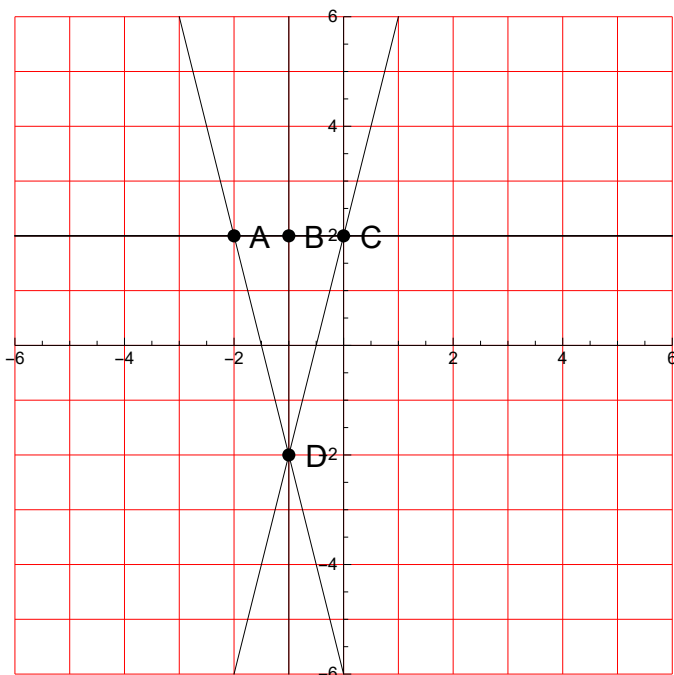

$AB: y = 2$
 $AC: y = 2$
 $AD: y = -4x - 6$
 $BC: y = 2$
 $BD: x = -1$
 $CD: y = 4x + 2$

16.

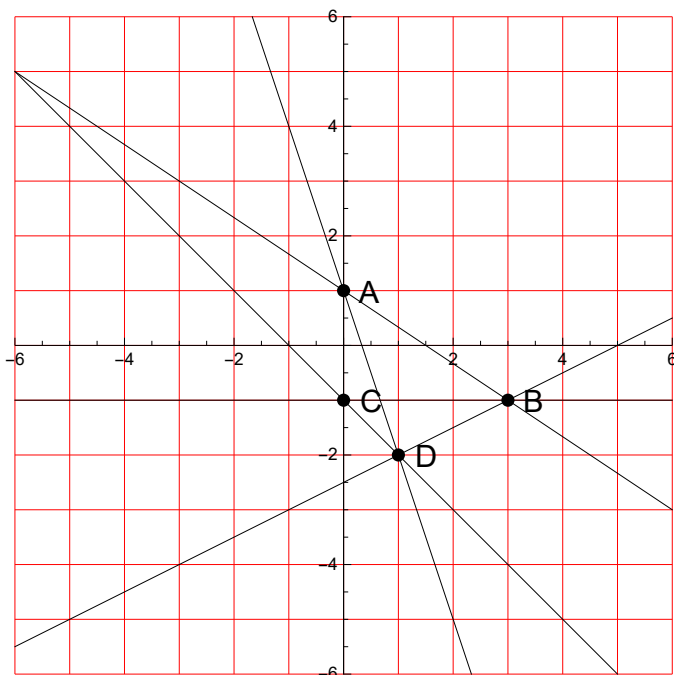

$AB: y = 1 - \frac{2x}{3}$
 $AC: x = 0$
 $AD: y = 1 - 3x$
 $BC: y = -1$
 $BD: y = \frac{x}{2} - \frac{5}{2}$
 $CD: y = -x - 1$

17.

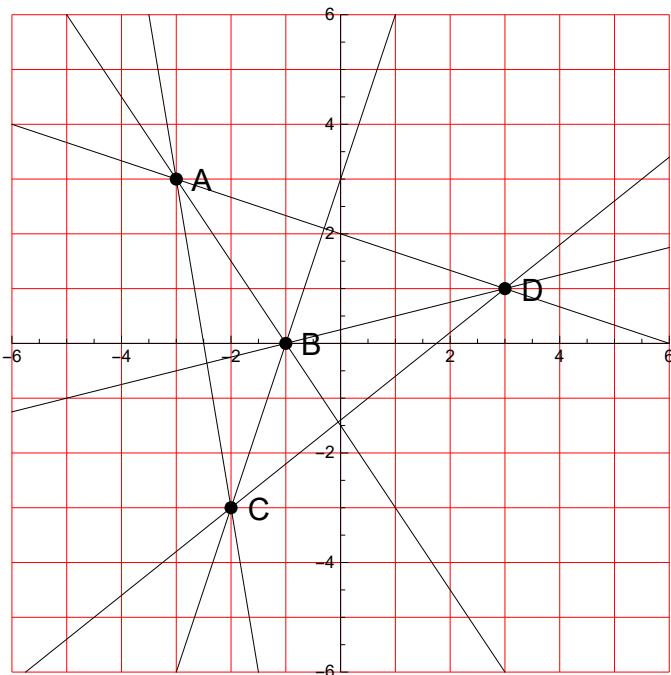

$$AB: y = -\frac{3x}{2} - \frac{3}{2}$$

$$AC: y = -6x - 15$$

$$AD: y = 2 - \frac{x}{3}$$

$$BC: y = 3x + 3$$

$$BD: y = \frac{x}{4} + \frac{1}{4}$$

$$CD: y = \frac{4x}{5} - \frac{7}{5}$$

18.

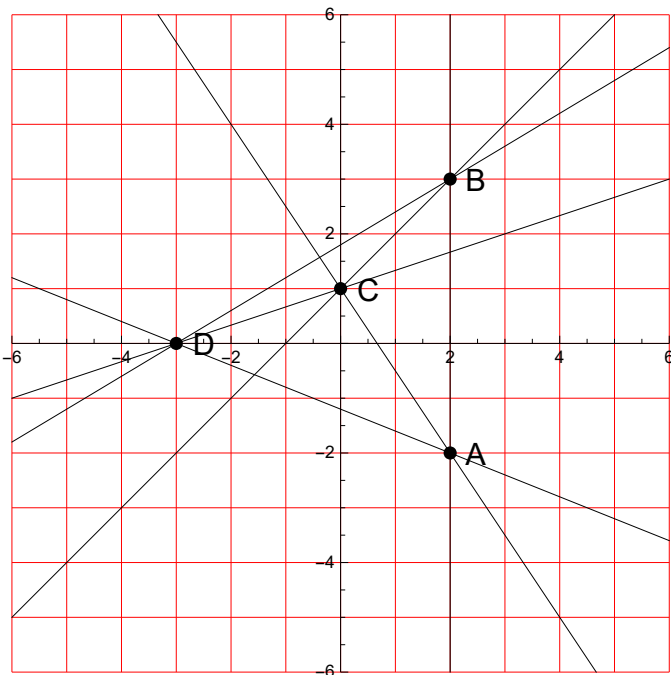

$$AB: x = 2$$

$$AC: y = 1 - \frac{3x}{2}$$

$$AD: y = -\frac{2x}{5} - \frac{6}{5}$$

$$BC: y = x + 1$$

$$BD: y = \frac{3x}{5} + \frac{9}{5}$$

$$CD: y = \frac{x}{3} + 1$$

19.

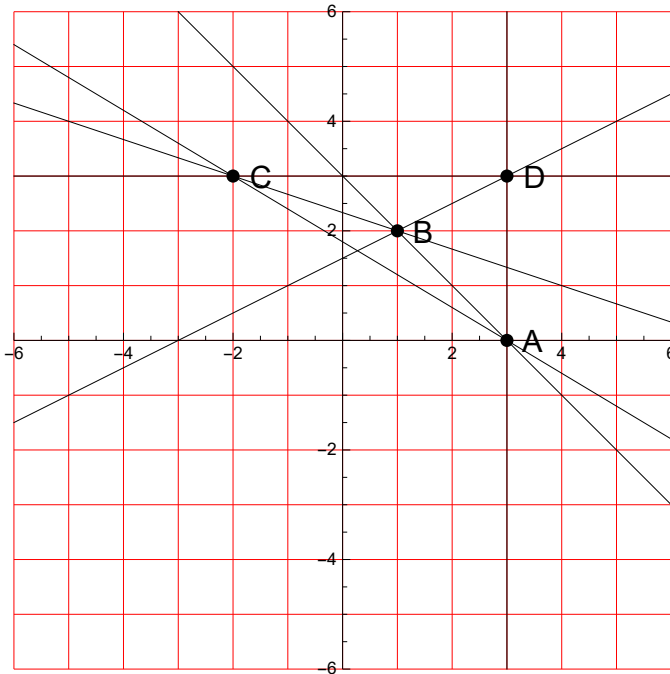

$$\begin{aligned} AB: y &= 3 - x \\ AC: y &= \frac{9}{5} - \frac{3x}{5} \\ AD: x &= 3 \\ BC: y &= \frac{7}{3} - \frac{x}{3} \\ BD: y &= \frac{x}{2} + \frac{3}{2} \\ CD: y &= 3 \end{aligned}$$

20.

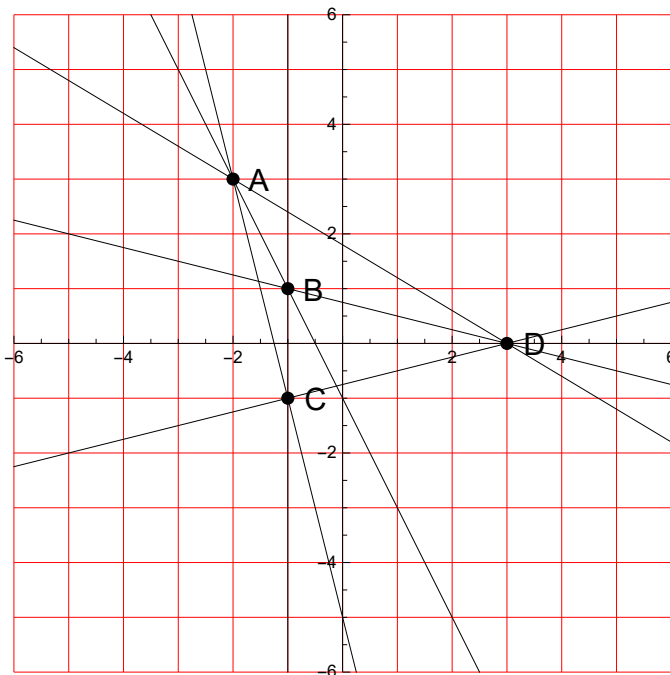

$$\begin{aligned} AB: y &= -2x - 1 \\ AC: y &= -4x - 5 \\ AD: y &= \frac{9}{5} - \frac{3x}{5} \\ BC: x &= -1 \\ BD: y &= \frac{3}{4} - \frac{x}{4} \\ CD: y &= \frac{x}{4} - \frac{3}{4} \end{aligned}$$

21.

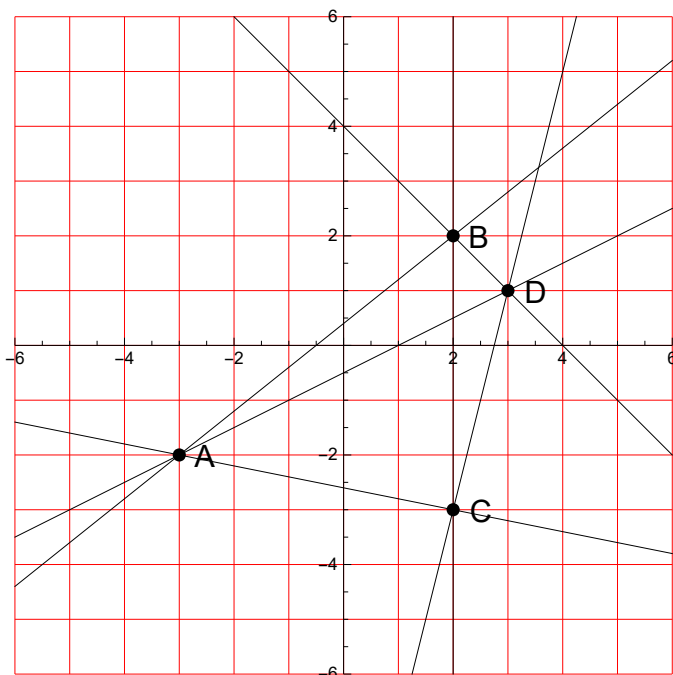

$$AB: y = \frac{4x}{5} + \frac{2}{5}$$

$$AC: y = -\frac{x}{5} - \frac{13}{5}$$

$$AD: y = \frac{x}{2} - \frac{1}{2}$$

$$BC: x = 2$$

$$BD: y = 4 - x$$

$$CD: y = 4x - 11$$

22.

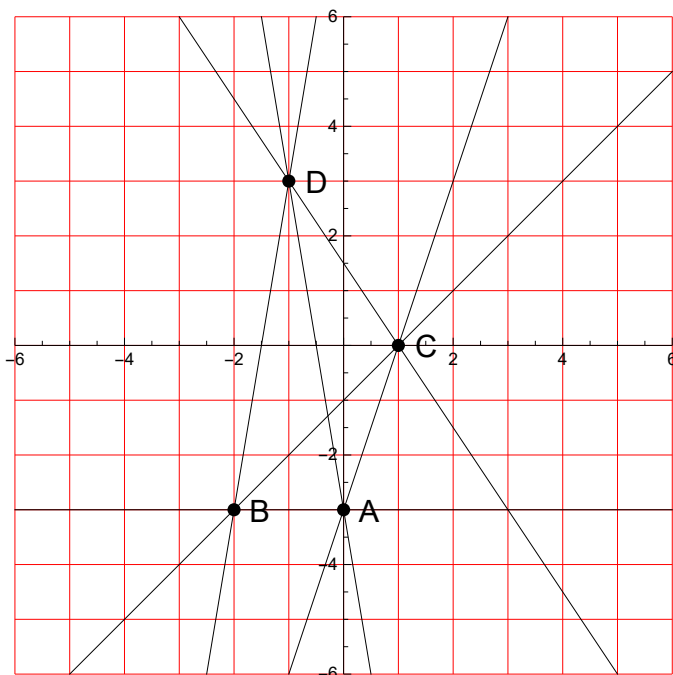

$$AB: y = -3$$

$$AC: y = 3x - 3$$

$$AD: y = -6x - 3$$

$$BC: y = x - 1$$

$$BD: y = 6x + 9$$

$$CD: y = \frac{3}{2} - \frac{3x}{2}$$

23.

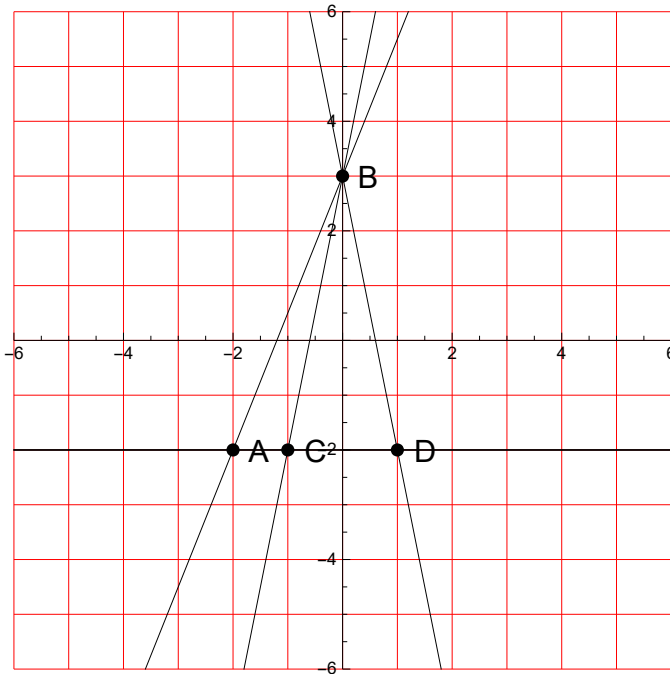

$$\begin{aligned} AB: y &= \frac{5x}{2} + 3 \\ AC: y &= -2 \\ AD: y &= -2 \\ BC: y &= 5x + 3 \\ BD: y &= 3 - 5x \\ CD: y &= -2 \end{aligned}$$

24.

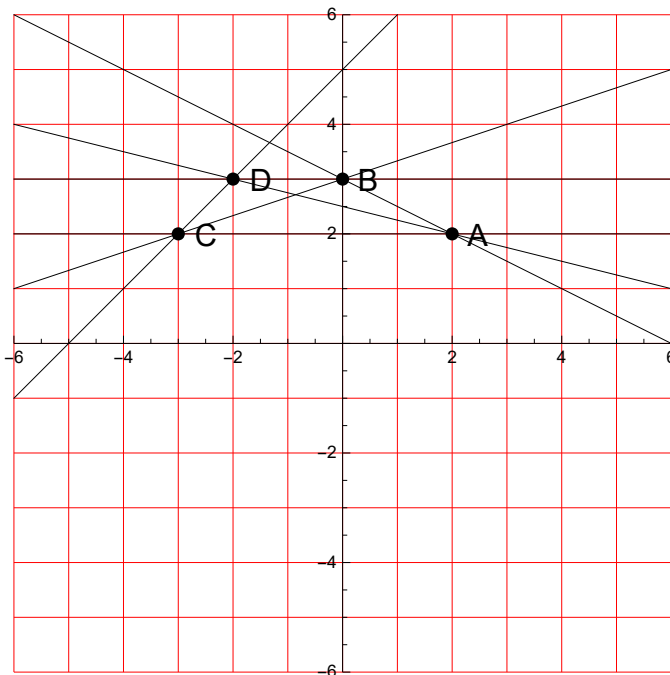

$$\begin{aligned} AB: y &= 3 - \frac{x}{2} \\ AC: y &= 2 \\ AD: y &= \frac{5}{2} - \frac{x}{4} \\ BC: y &= \frac{x}{3} + 3 \\ BD: y &= 3 \\ CD: y &= x + 5 \end{aligned}$$

25.

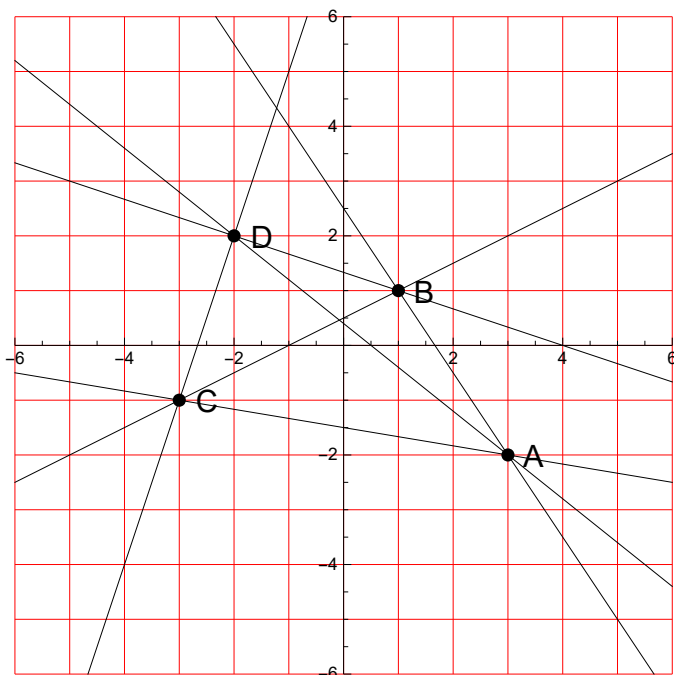

$$AB: y = \frac{5}{2} - \frac{3x}{2}$$

$$AC: y = -\frac{x}{6} - \frac{3}{2}$$

$$AD: y = \frac{2}{5} - \frac{4x}{5}$$

$$BC: y = \frac{x}{2} + \frac{1}{2}$$

$$BD: y = \frac{4}{3} - \frac{x}{3}$$

$$CD: y = 3x + 8$$

26.

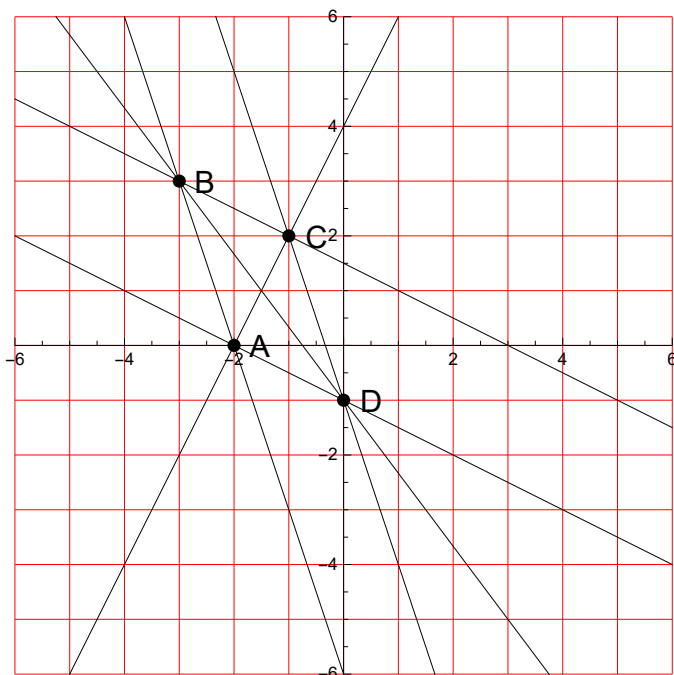

$$AB: y = -3x - 6$$

$$AC: y = 2x + 4$$

$$AD: y = -\frac{x}{2} - 1$$

$$BC: y = \frac{3}{2} - \frac{x}{2}$$

$$BD: y = -\frac{4x}{3} - 1$$

$$CD: y = -3x - 1$$

27.

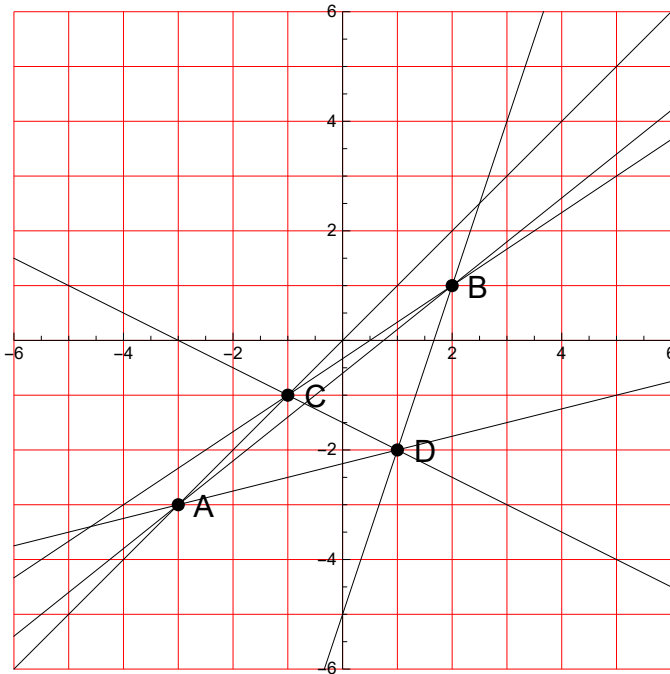

$$AB: y = \frac{4x}{5} - \frac{3}{5}$$

$$AC: y = x$$

$$AD: y = \frac{x}{4} - \frac{9}{4}$$

$$BC: y = \frac{2x}{3} - \frac{1}{3}$$

$$BD: y = 3x - 5$$

$$CD: y = -\frac{x}{2} - \frac{3}{2}$$

28.

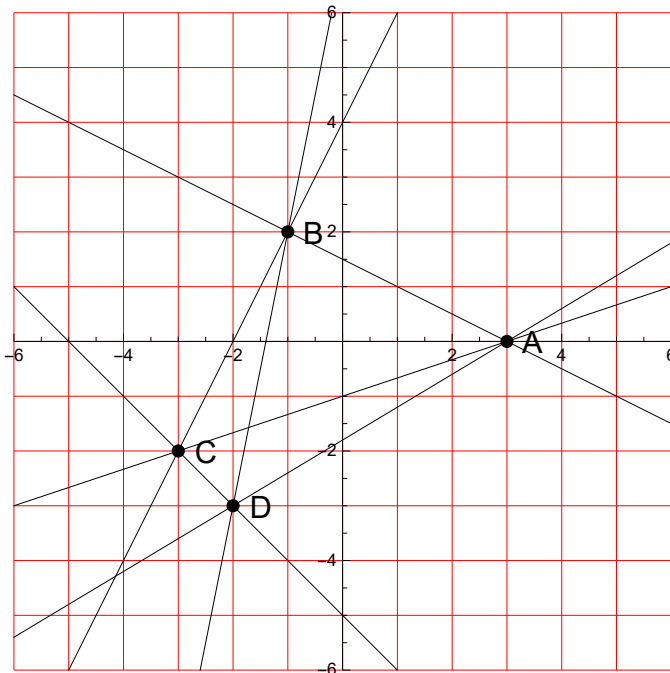

$$AB: y = \frac{3}{2} - \frac{x}{2}$$

$$AC: y = \frac{x}{3} - 1$$

$$AD: y = \frac{3x}{5} - \frac{9}{5}$$

$$BC: y = 2x + 4$$

$$BD: y = 5x + 7$$

$$CD: y = -x - 5$$

29.

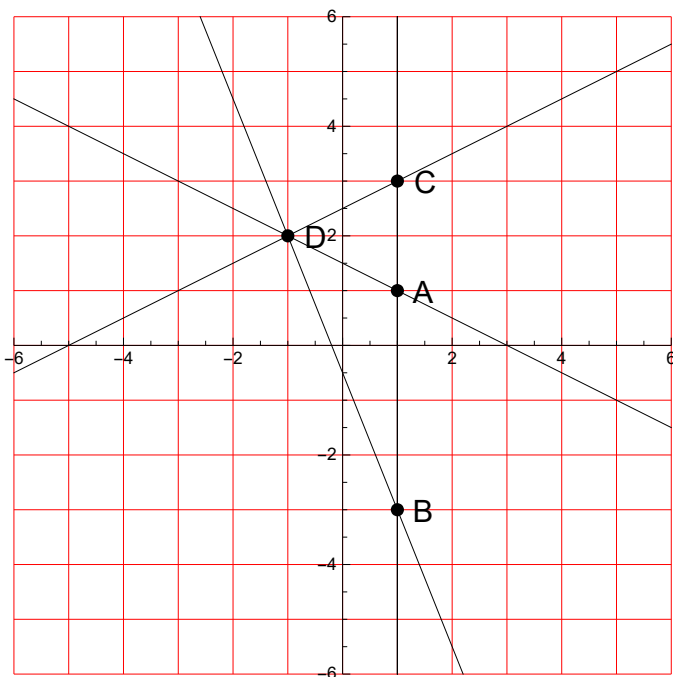

$$AB: x = 1$$

$$AC: x = 1$$

$$AD: y = \frac{3}{2} - \frac{x}{2}$$

$$BC: x = 1$$

$$BD: y = -\frac{5x}{2} - \frac{1}{2}$$

$$CD: y = \frac{x}{2} + \frac{5}{2}$$

30.

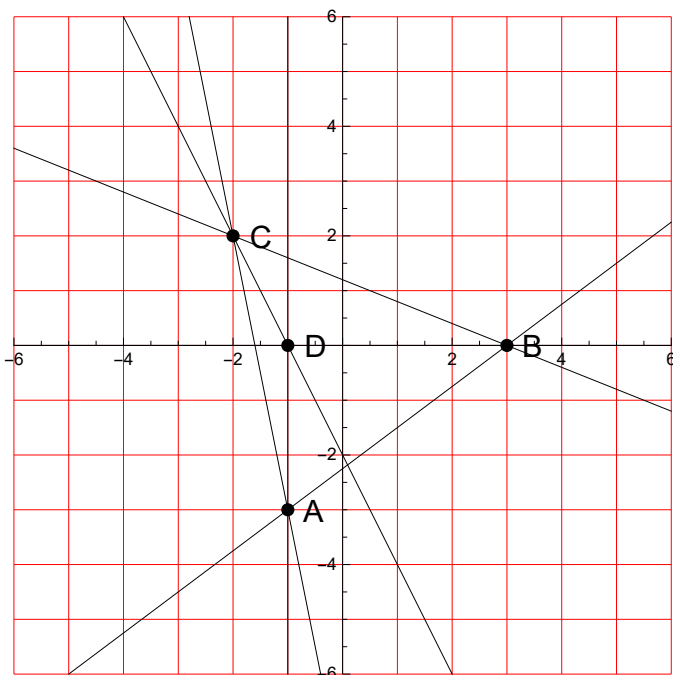

$$AB: y = \frac{3x}{4} - \frac{9}{4}$$

$$AC: y = -5x - 8$$

$$AD: x = -1$$

$$BC: y = \frac{6}{5} - \frac{2x}{5}$$

$$BD: y = 0$$

$$CD: y = -2x - 2$$