

prof. Matemko

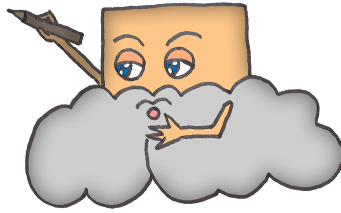

Enojni labirinti na običajnih telesih

Na telesu, ki je dano z mrežo, poišči najkrajšo pot od temnejše do svetlejše pike!
Iz neke strani lahko preideš na sosedno stran mnogoterca,
če in samo če meja med njima ni prikazana z odebeljeno črto.

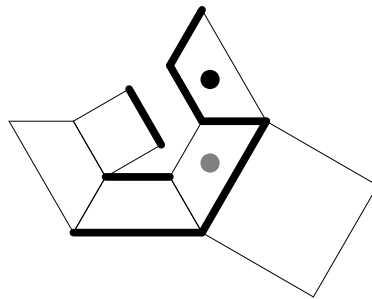

odgovor

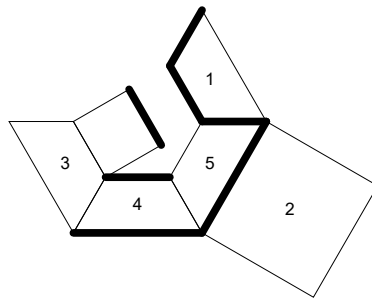

MATHEMA

1

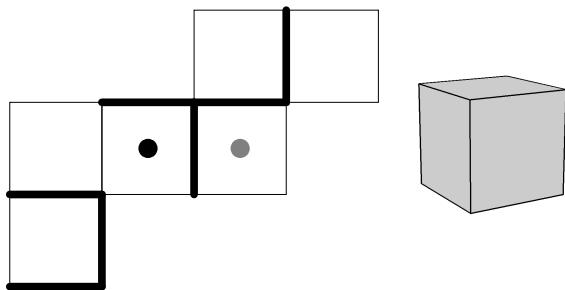

2

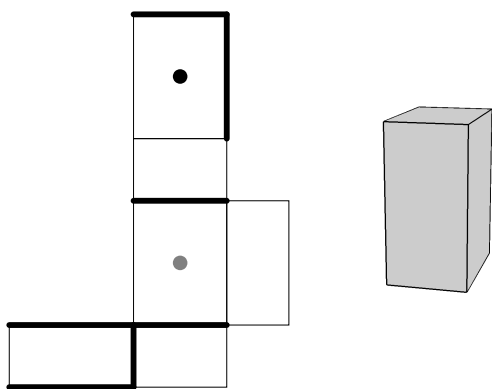

3

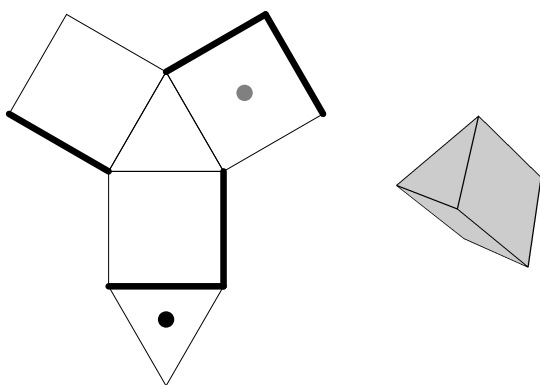

4

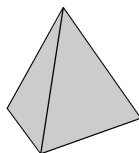
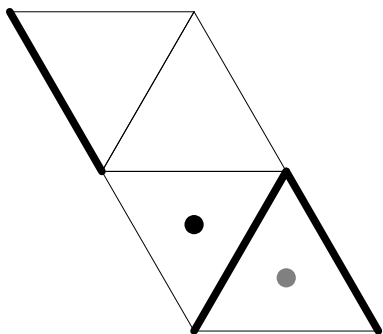

5

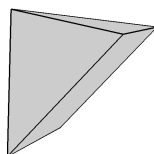
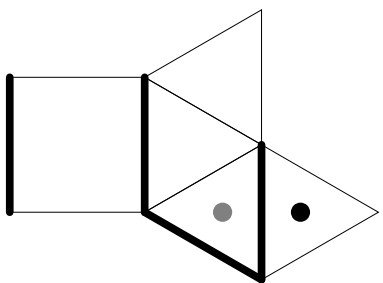

6

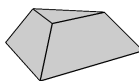
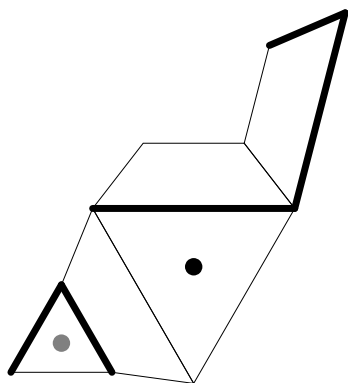

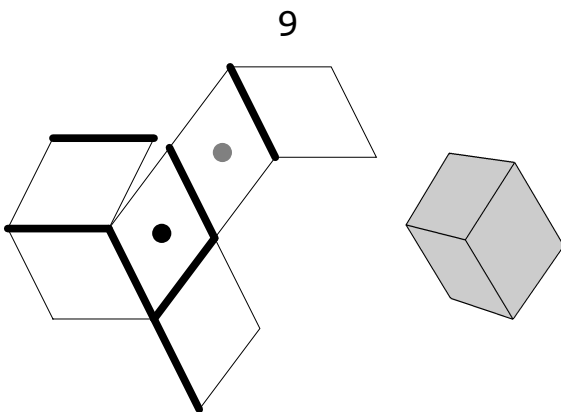
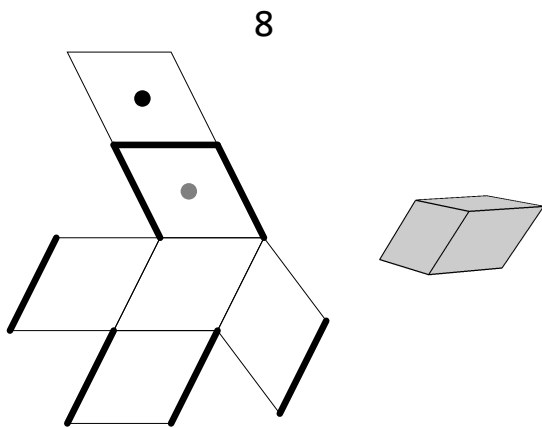
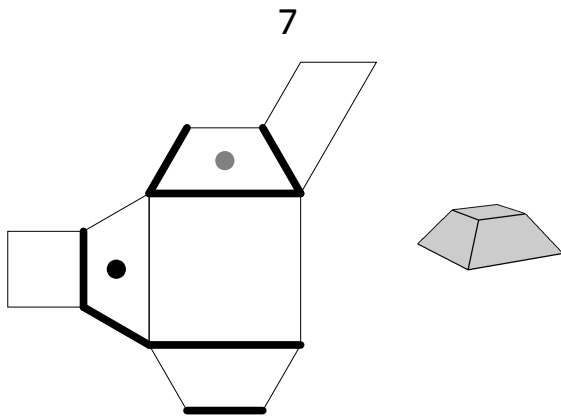

10

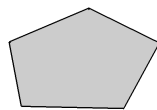
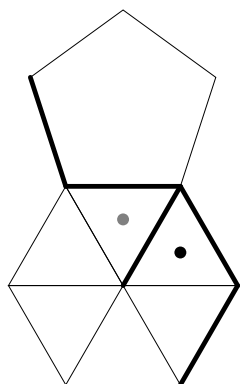

11

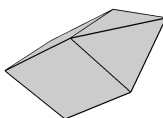
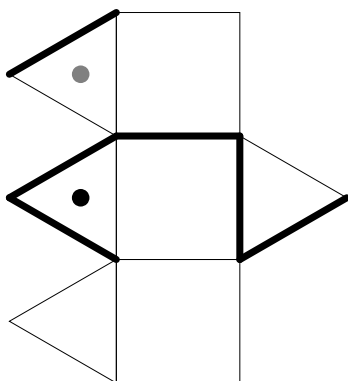

12

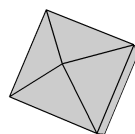
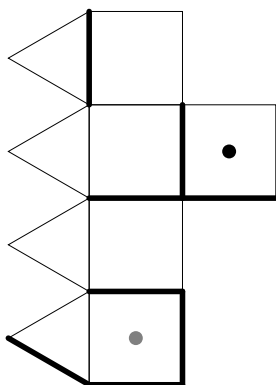

13

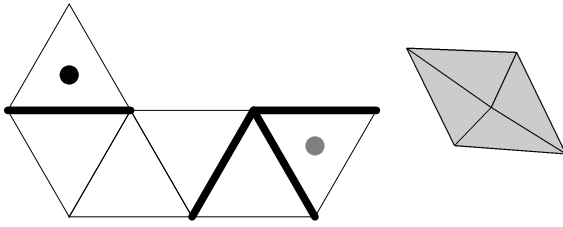

14

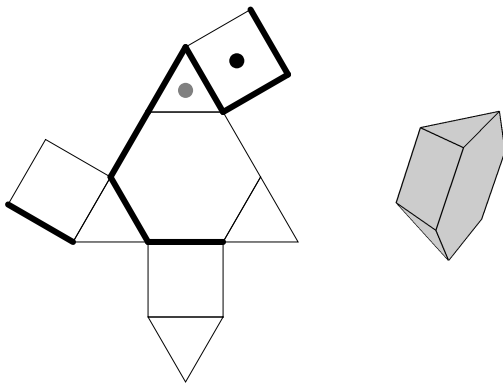

15

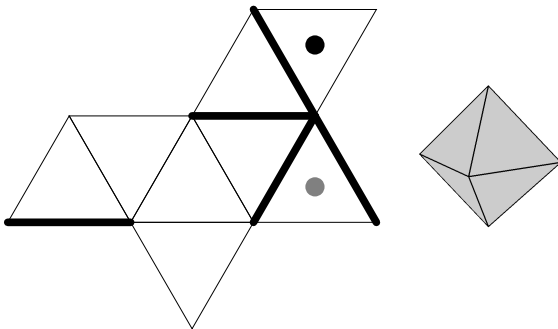

16

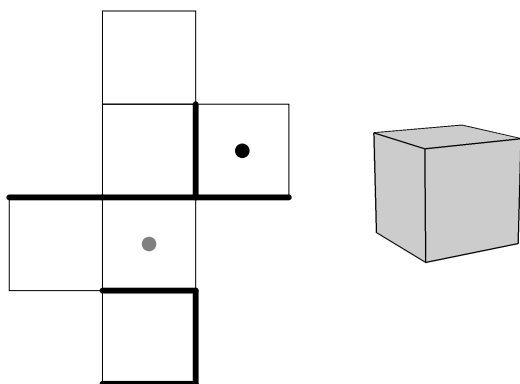

17

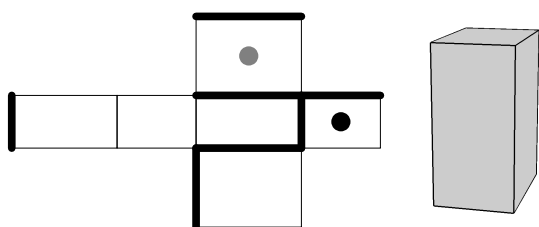

18

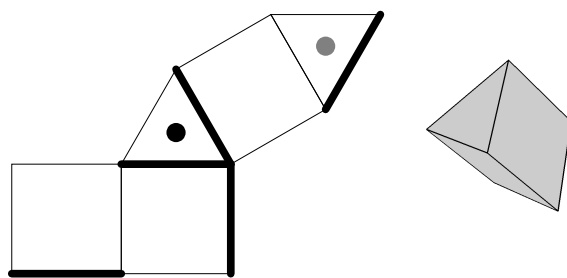

19

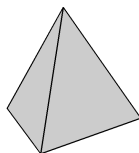
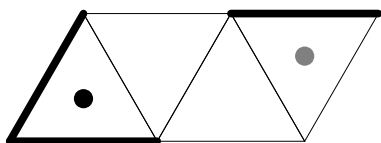

20

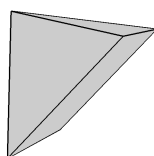
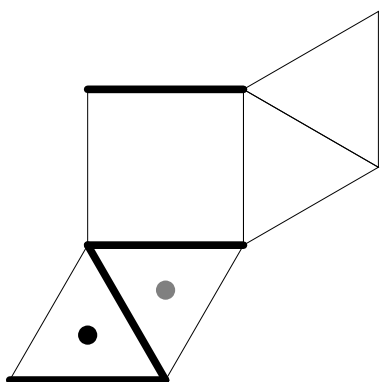

21

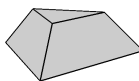
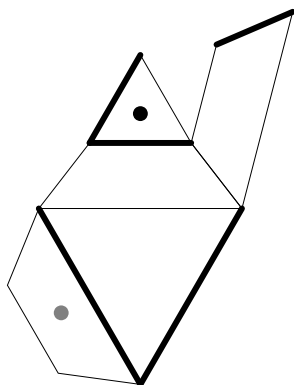

22

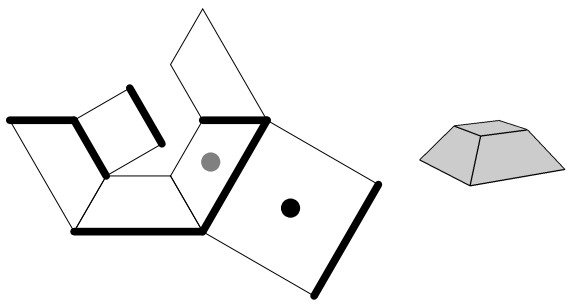

23

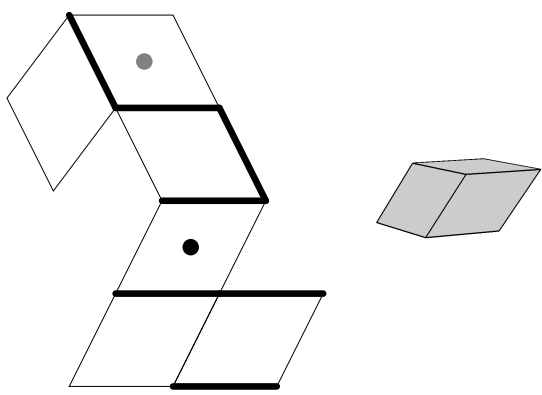

24

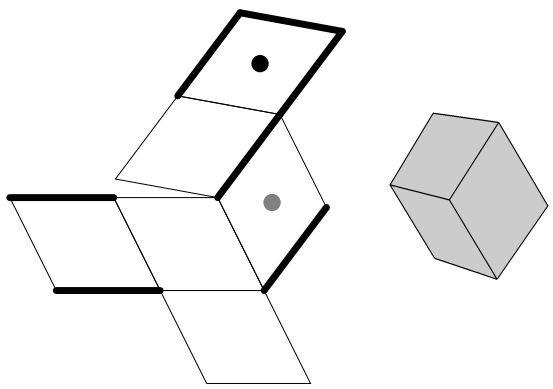

25

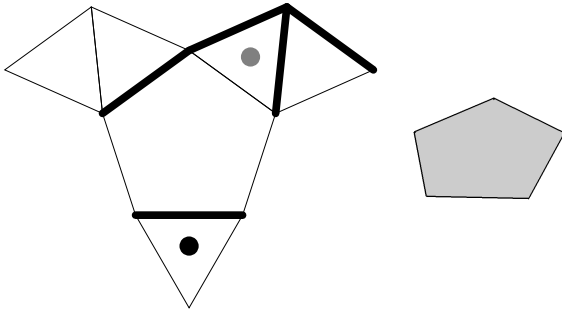

26

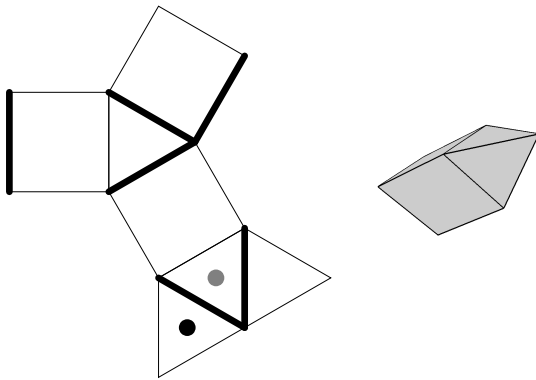

27

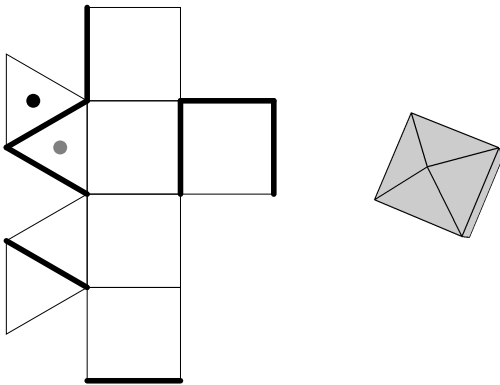

28

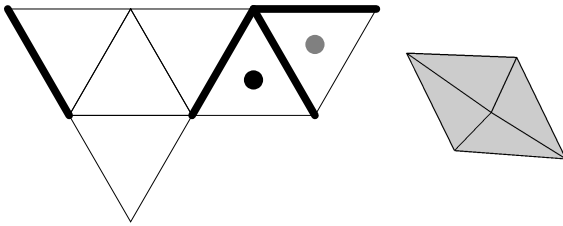

29

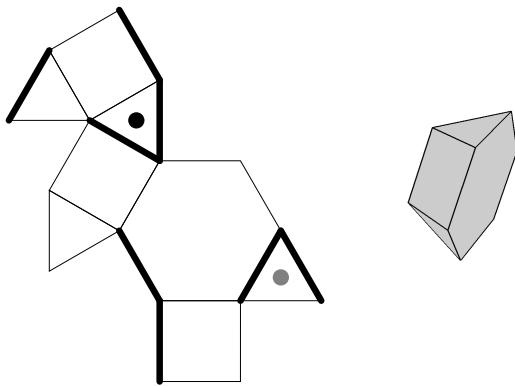

30

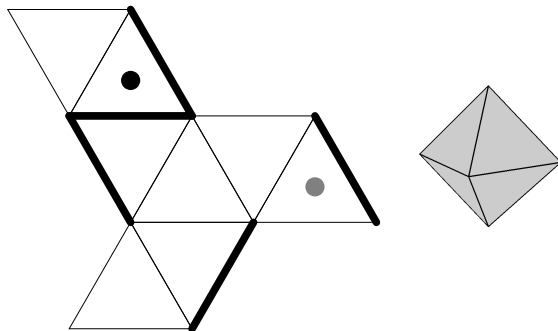

31

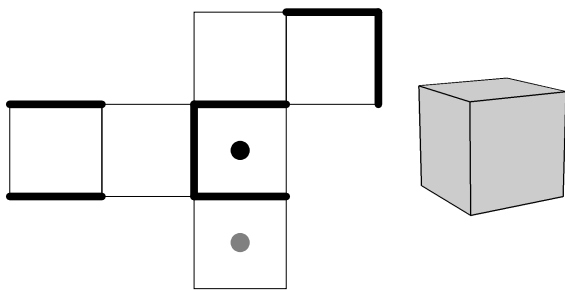

32

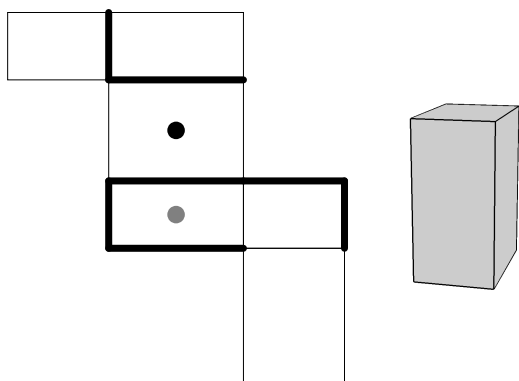

33

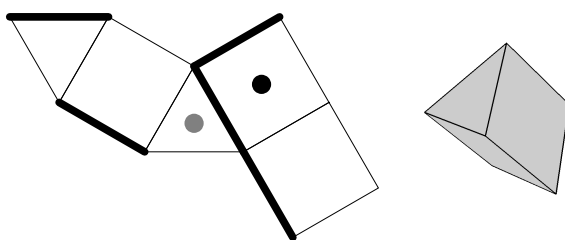

34

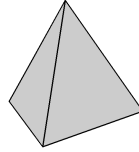
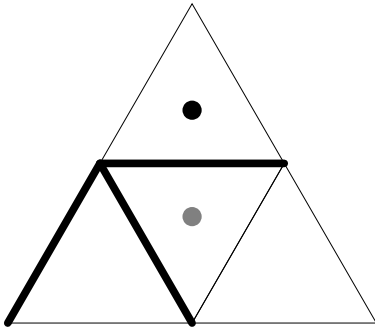

35

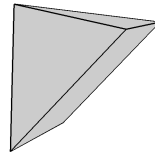
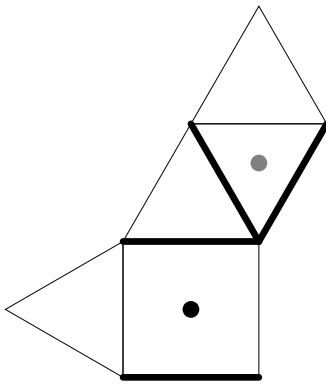

36

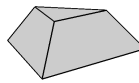
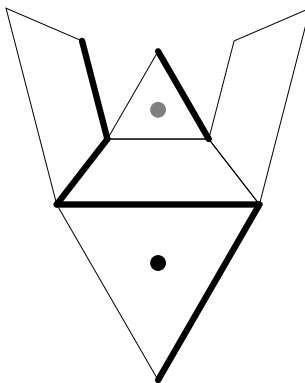

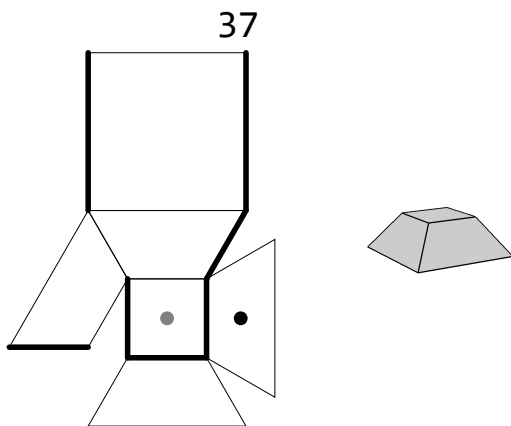

38

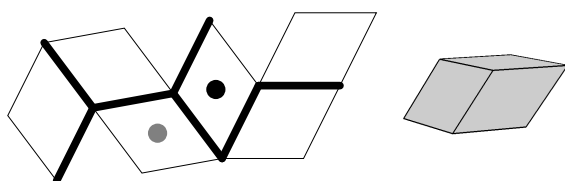

39

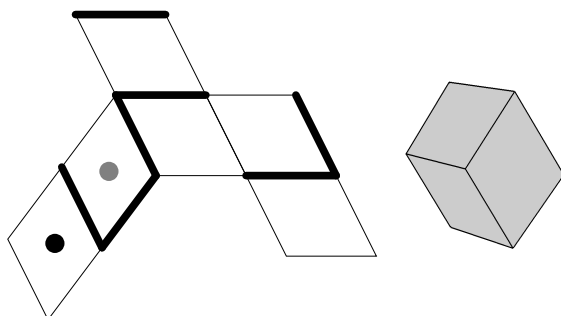

40

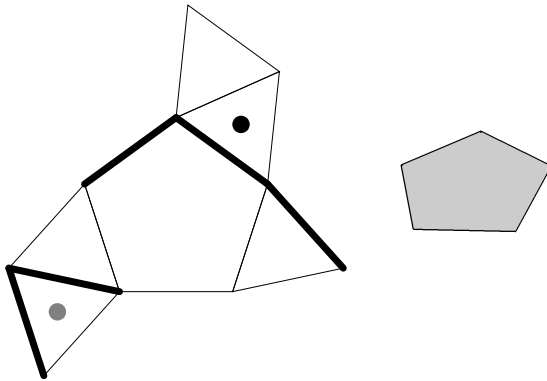

41

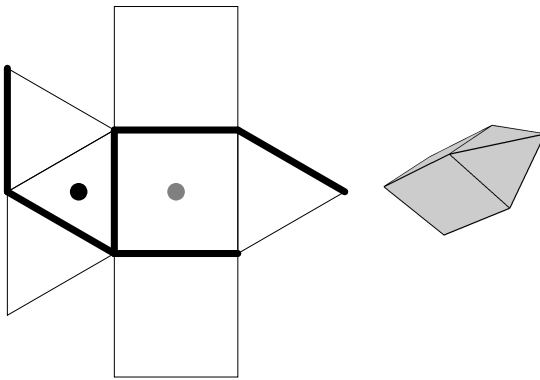

42

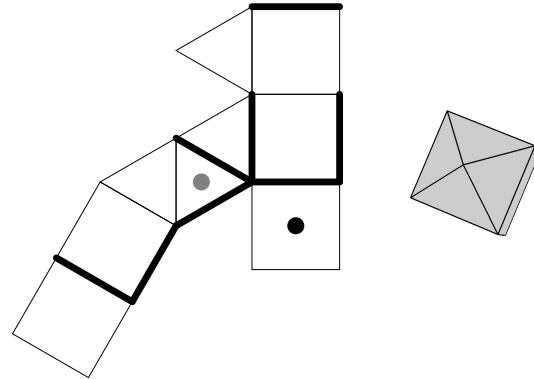

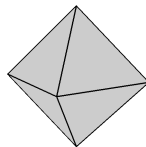
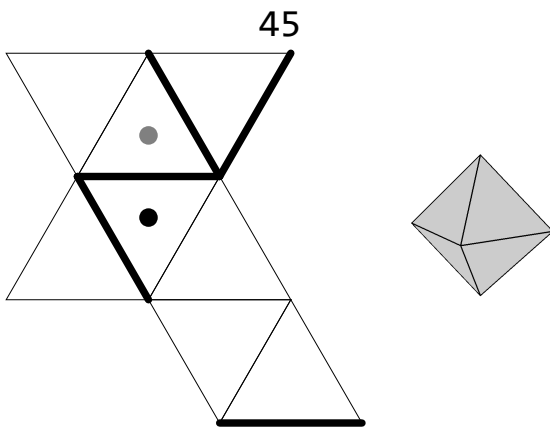
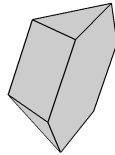
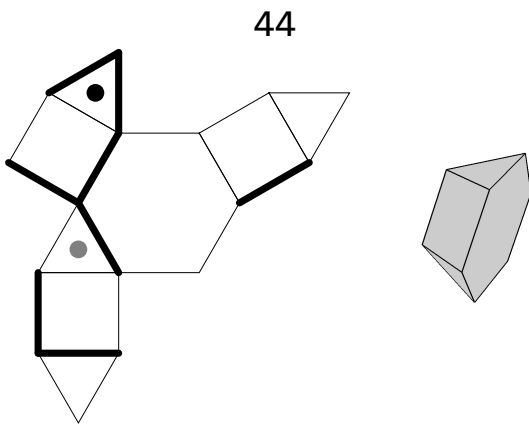
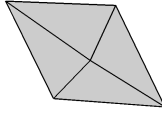
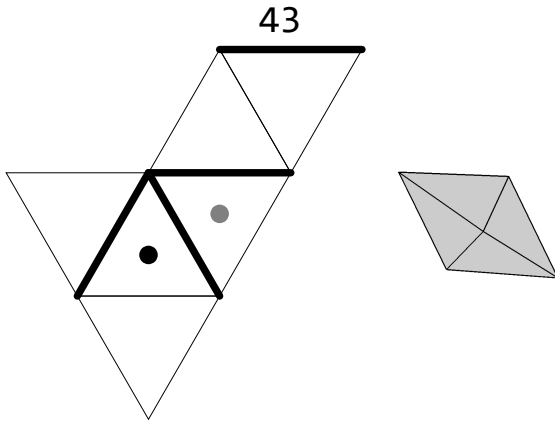

46

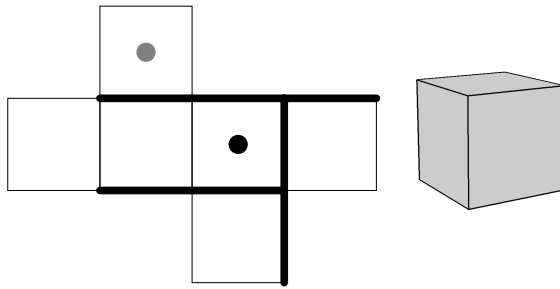

47

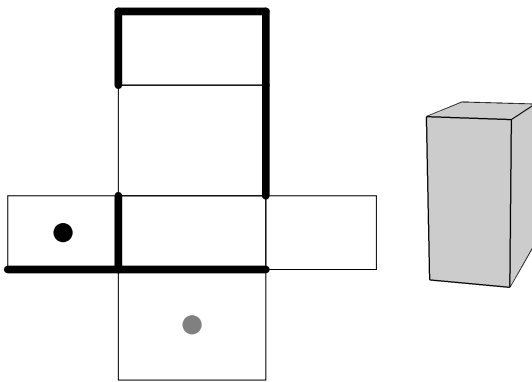

48

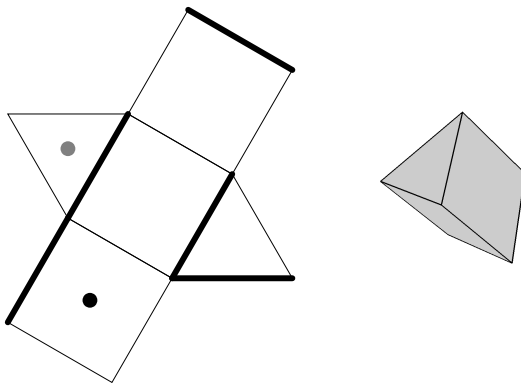

49

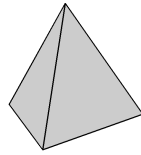
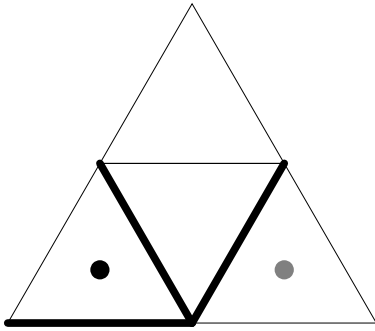

50

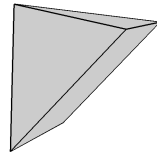
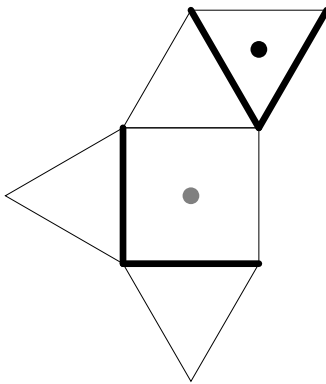

51

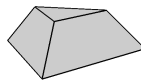
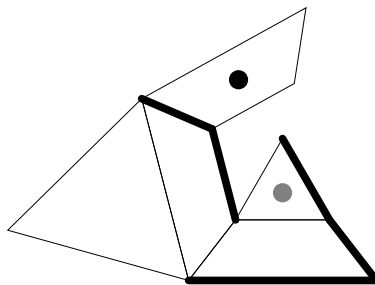

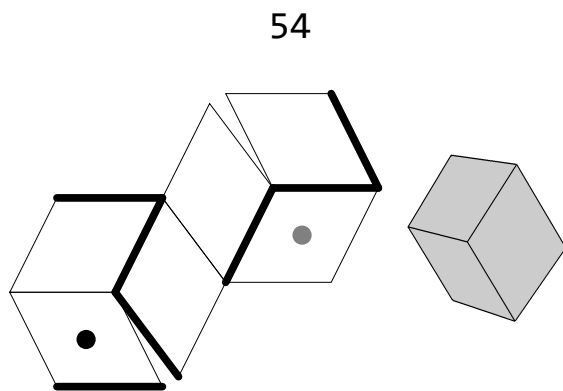
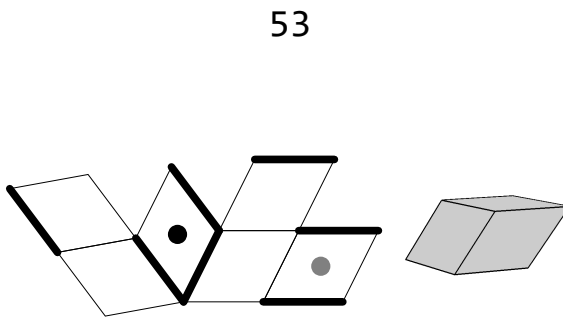
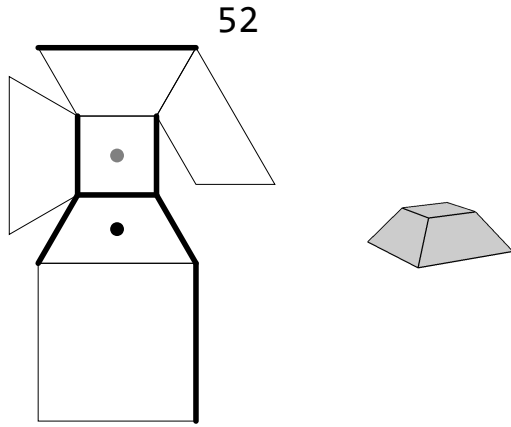

55

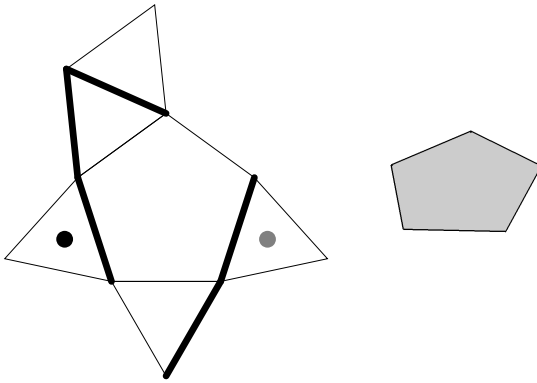

56

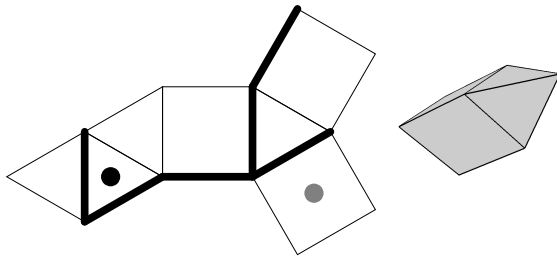

57

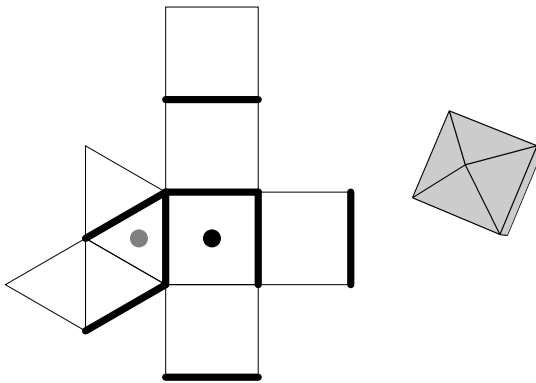

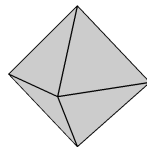
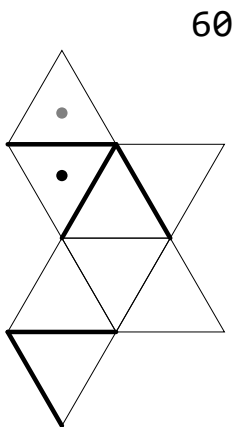
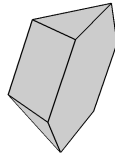
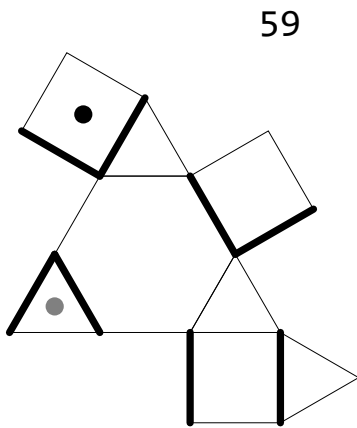
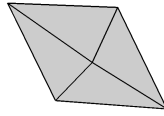
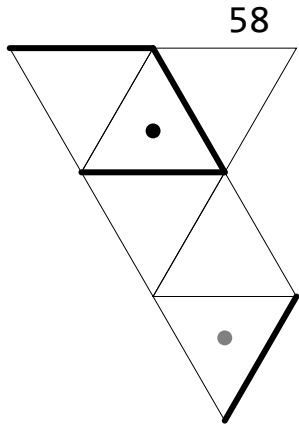

1

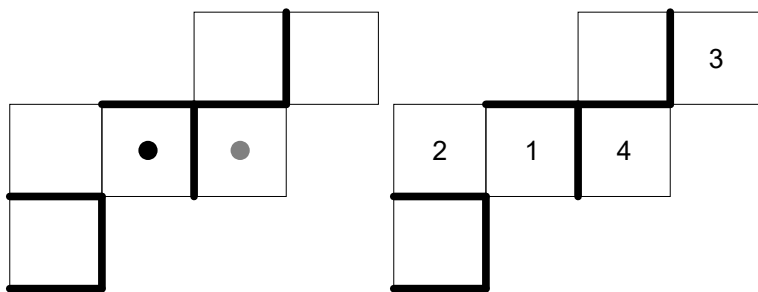

2

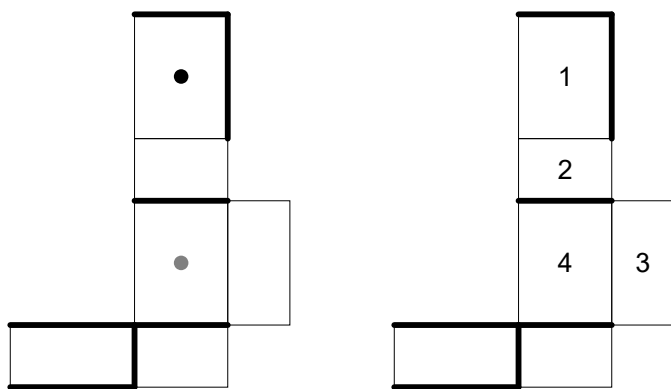

3

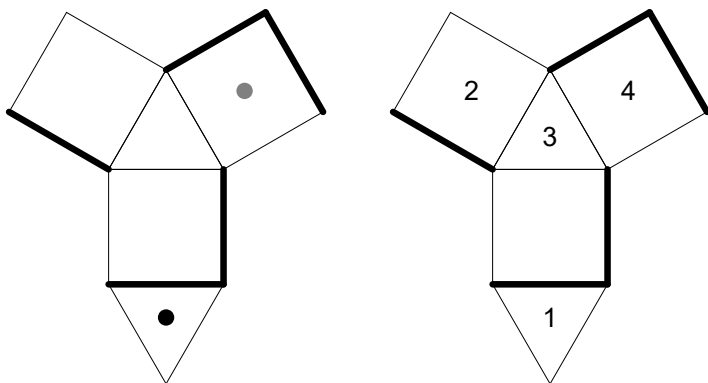

4

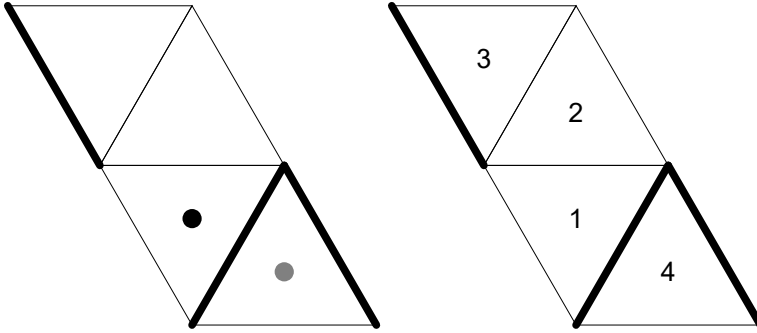

5

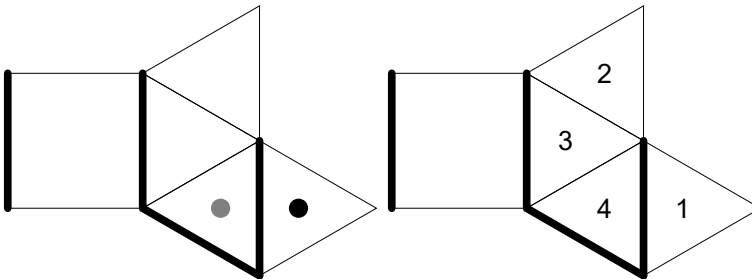

6

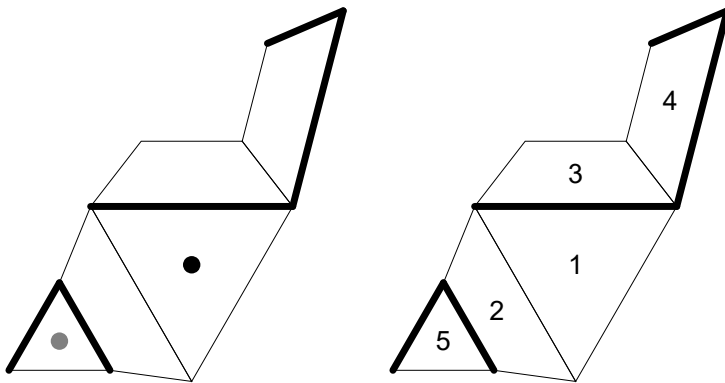

7

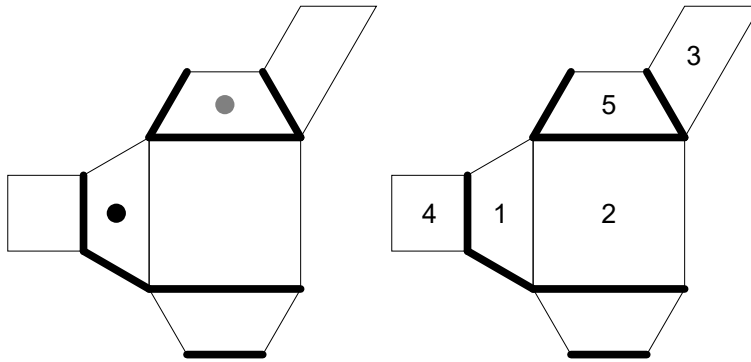

8

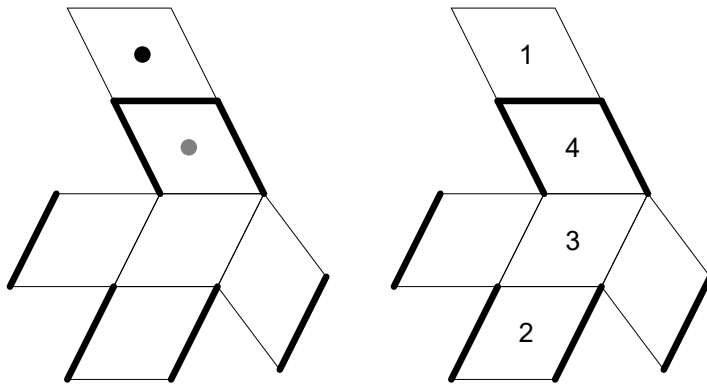

9

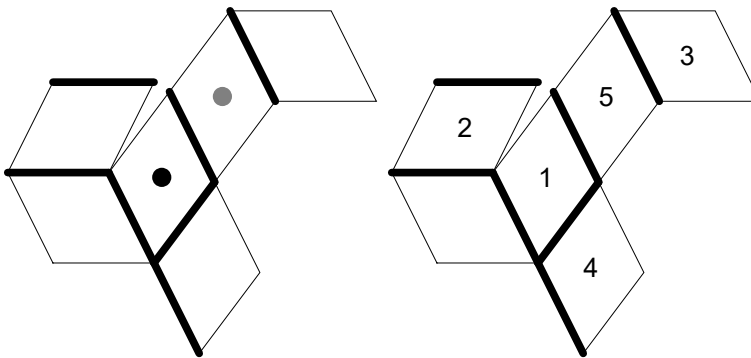

10

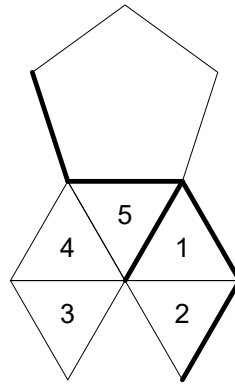
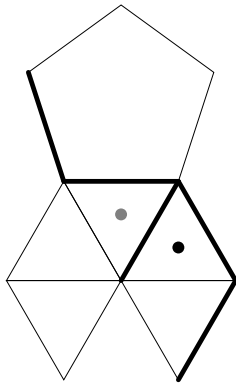

11

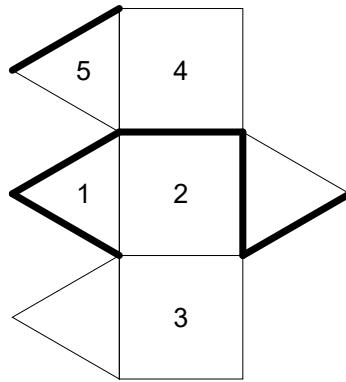
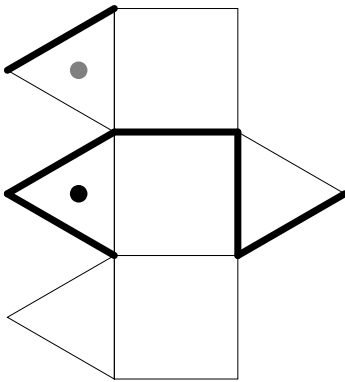

12

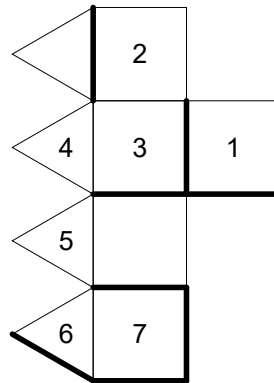
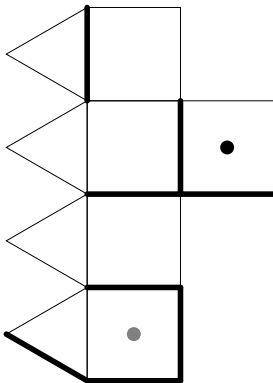

13

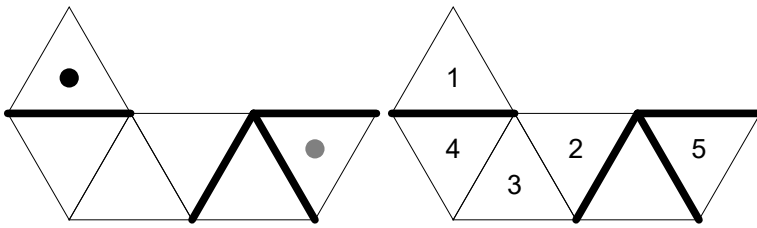

14

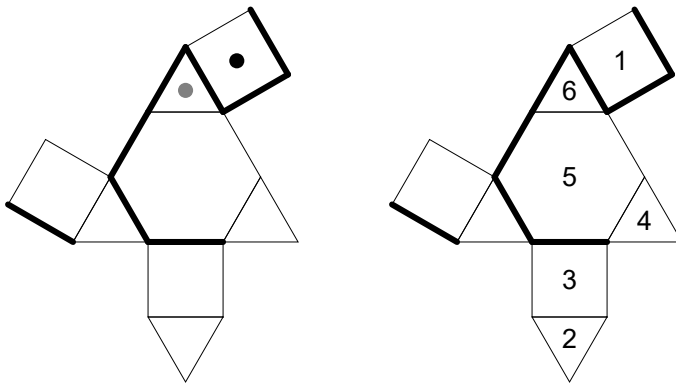

15

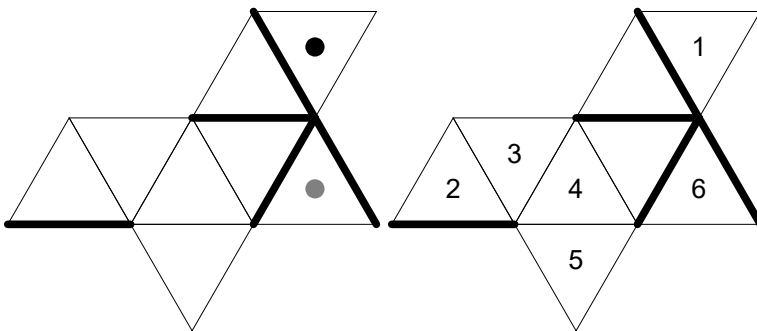

16

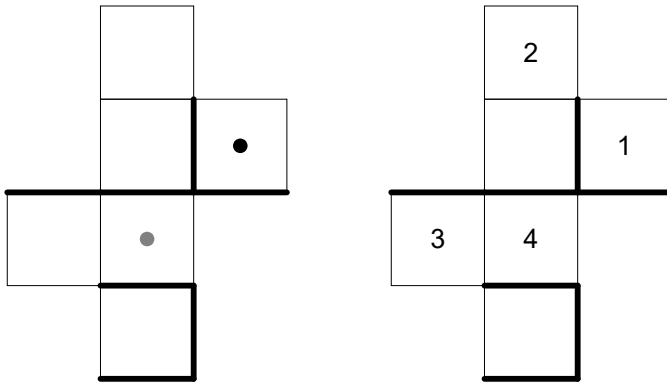

17

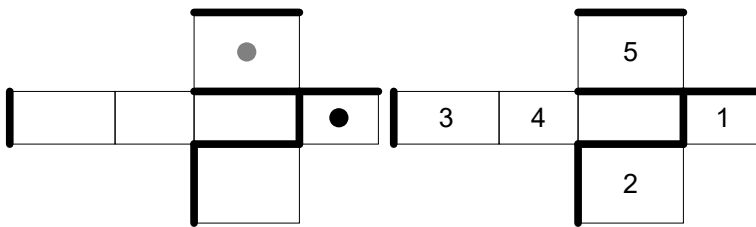

18

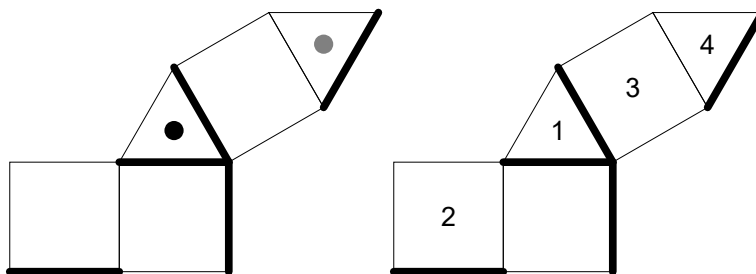

19



20

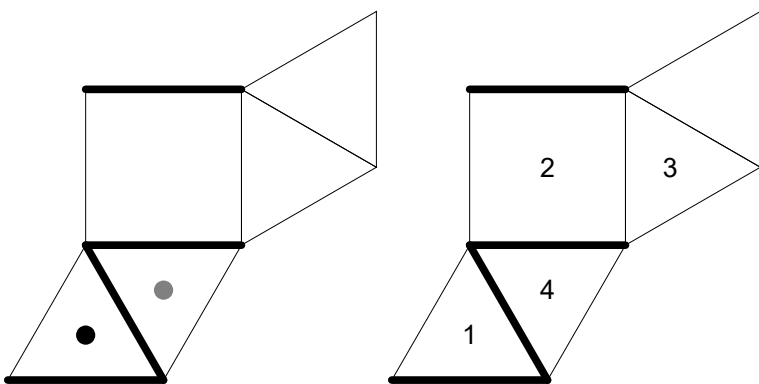

21

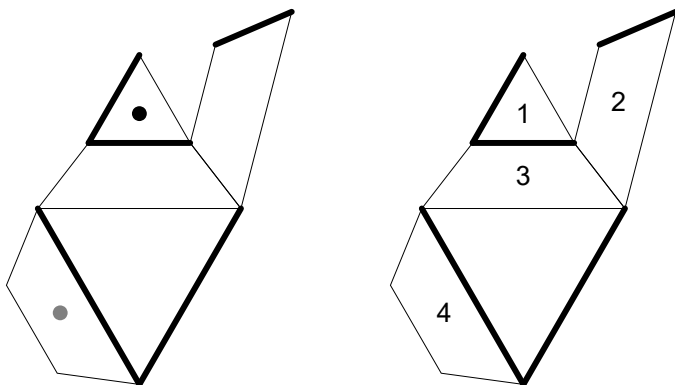

22

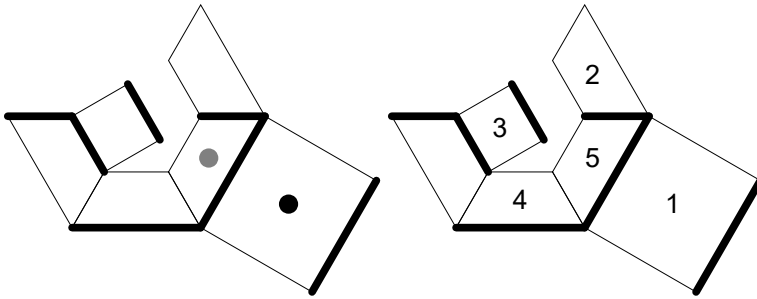

23

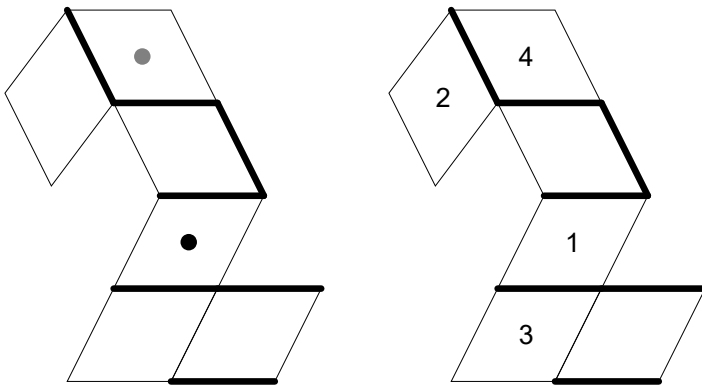

24

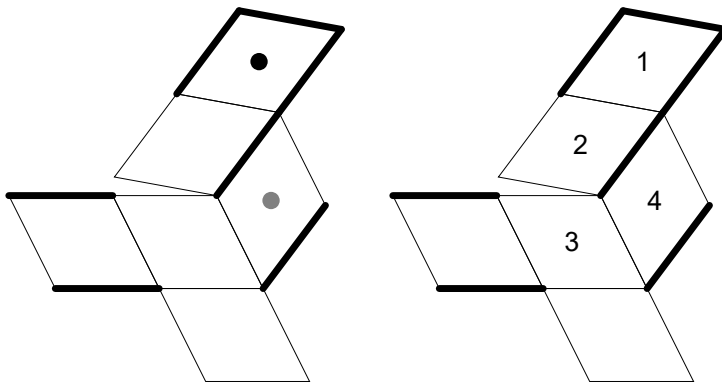

25

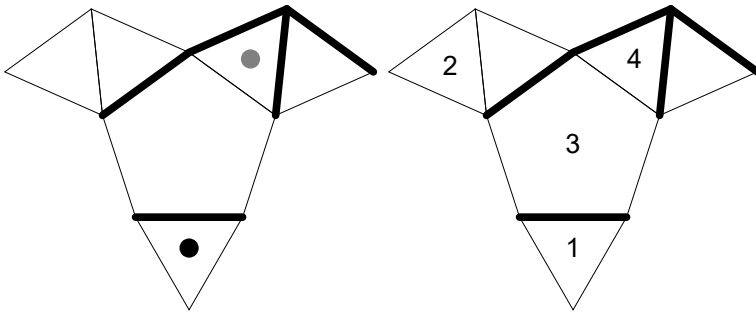

26

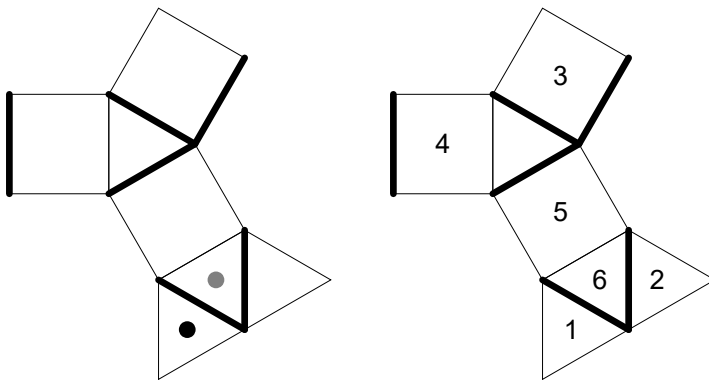

27

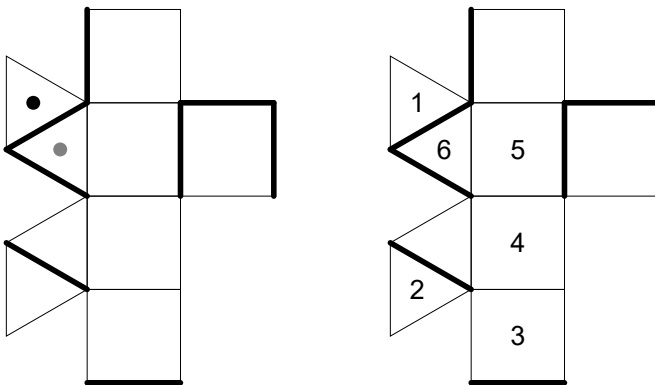

28

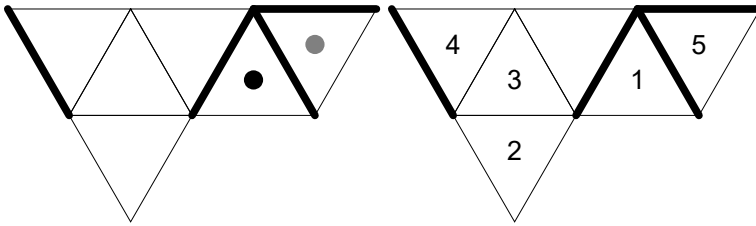

29

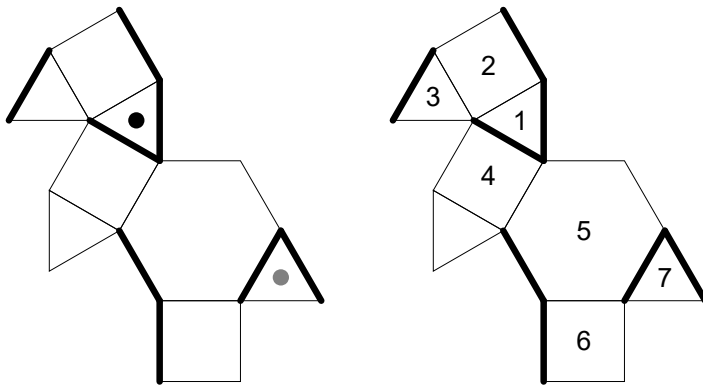

30

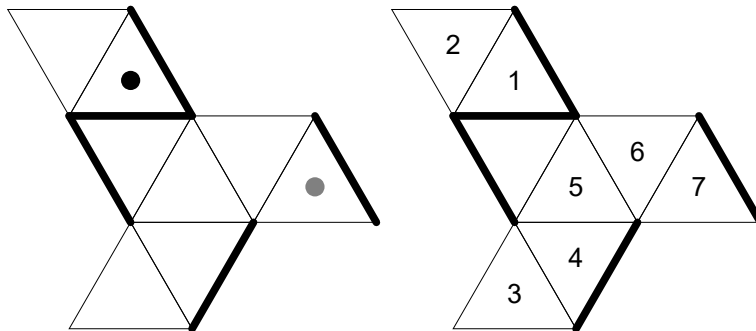

31

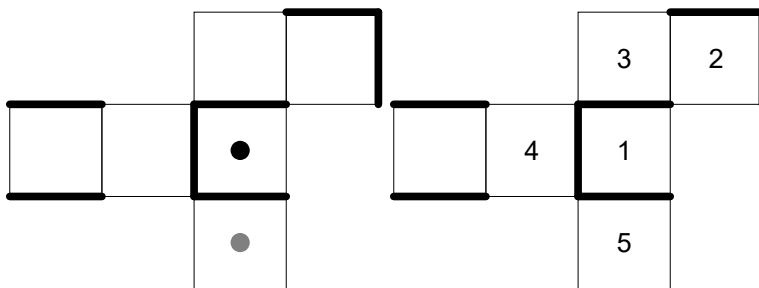

32

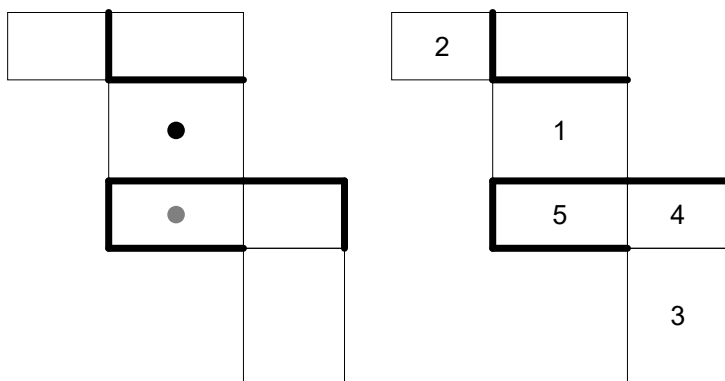

33

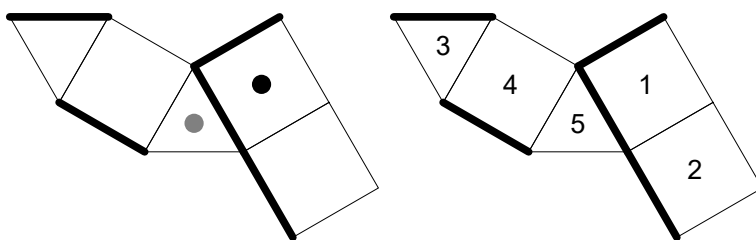

34

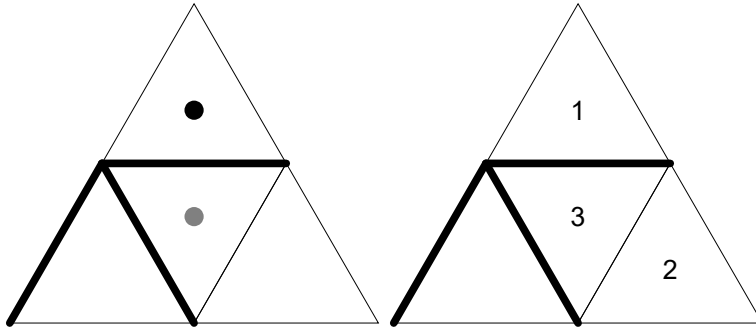

35

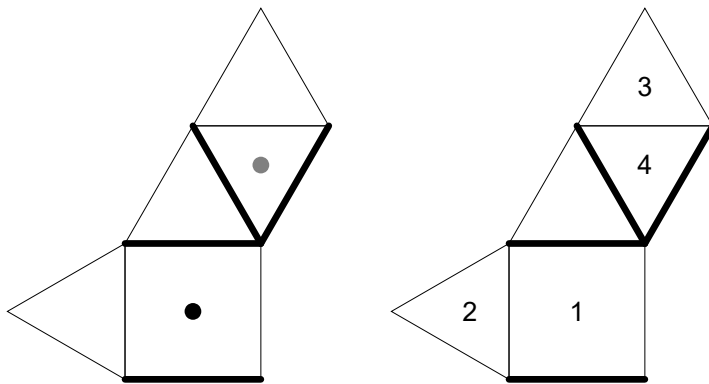

36

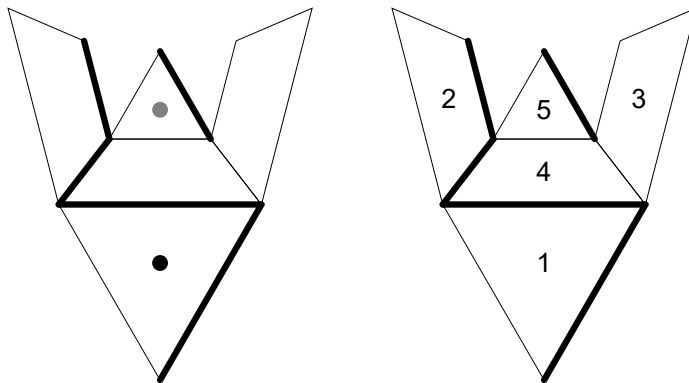

37

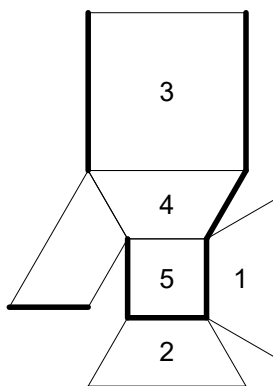
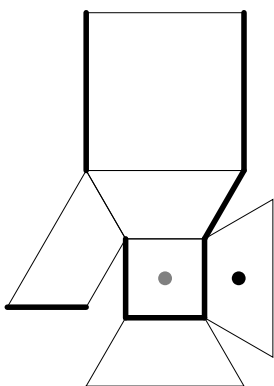

38

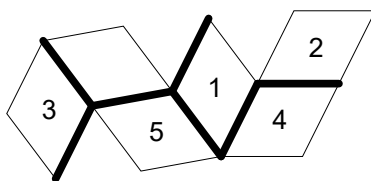
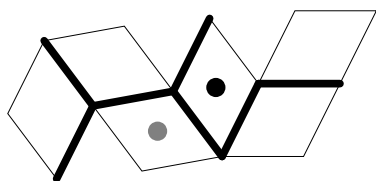

39

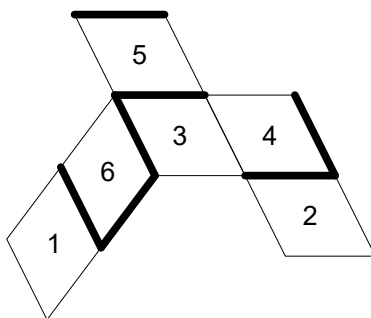
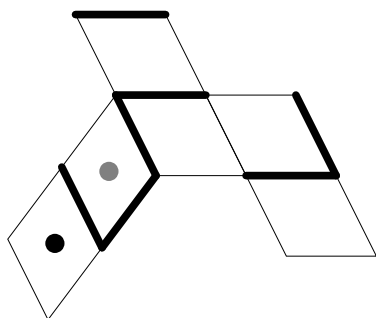

40

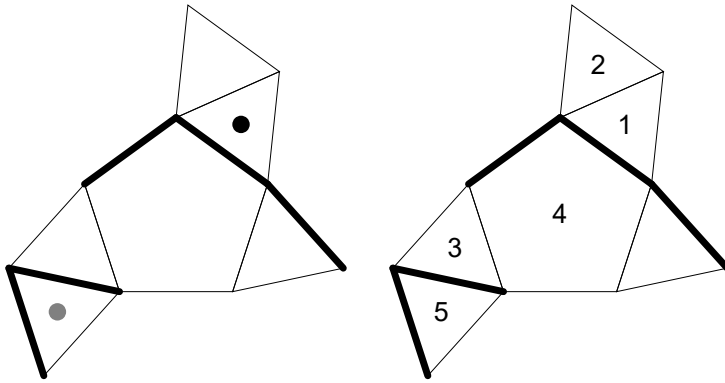

41

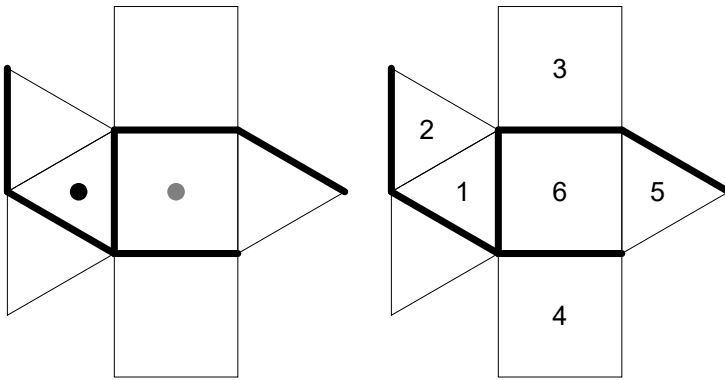

42

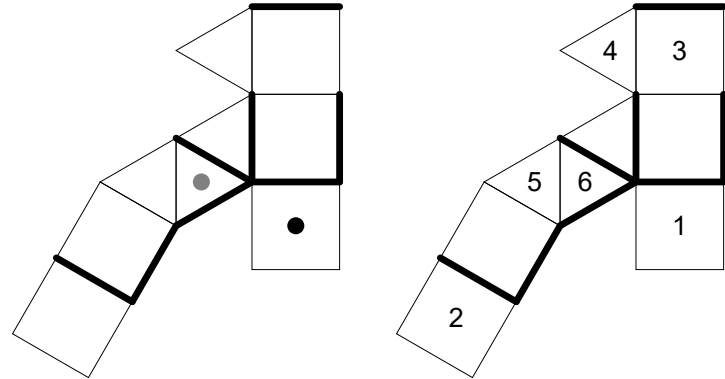

43

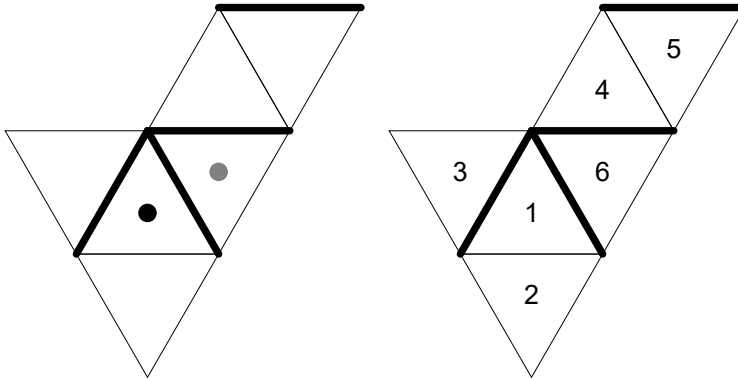

44

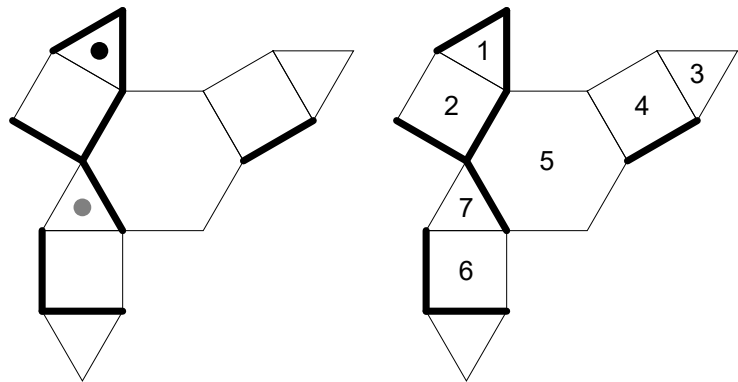

45

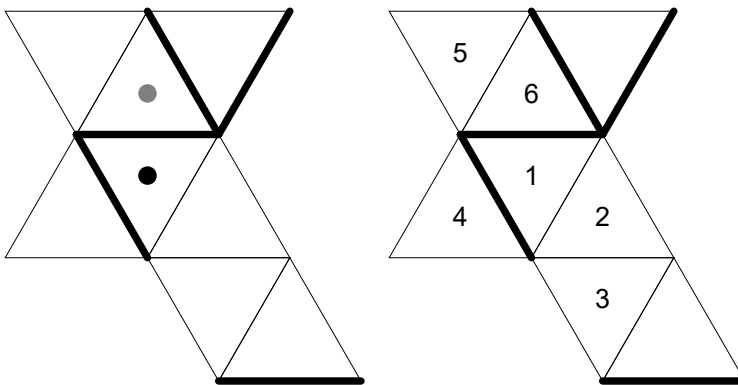

46

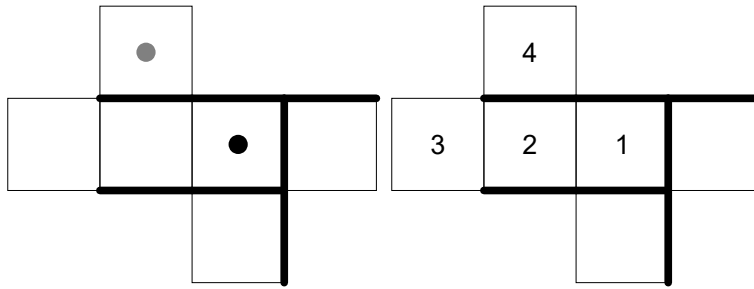

47

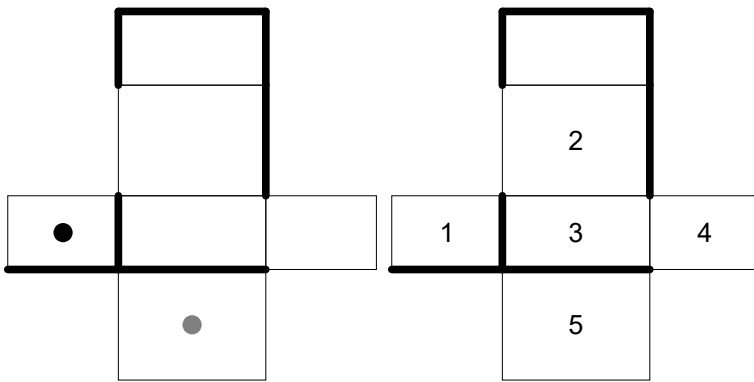

48

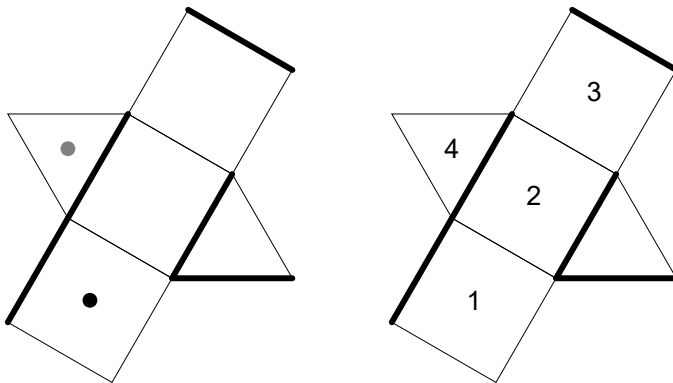

49

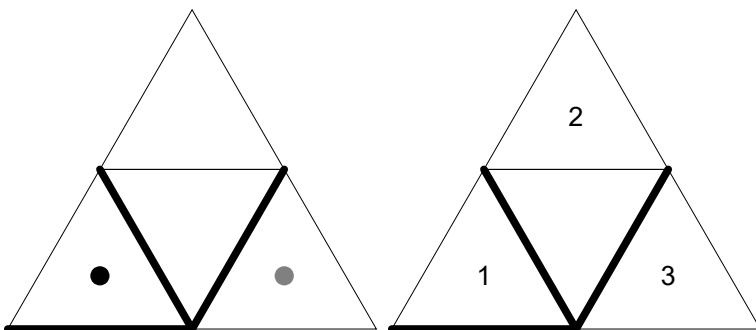

50

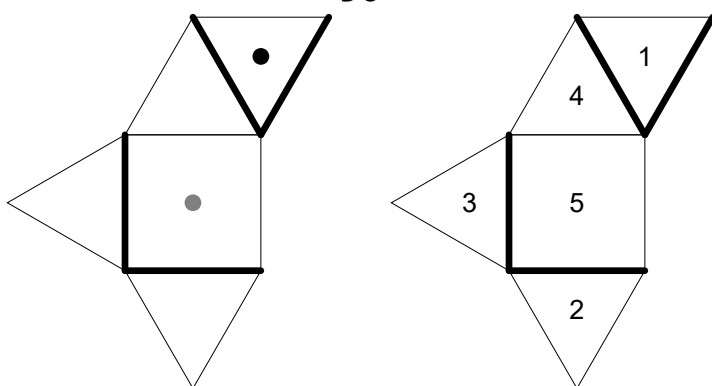

51

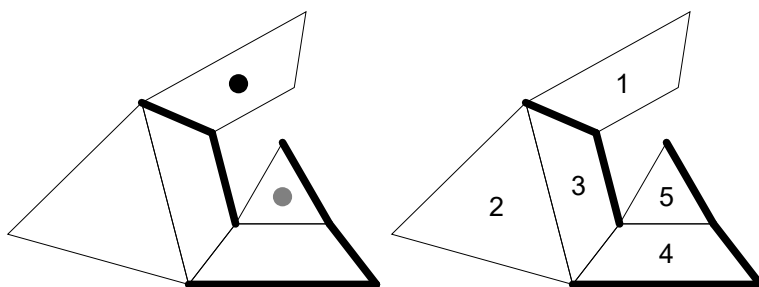

52

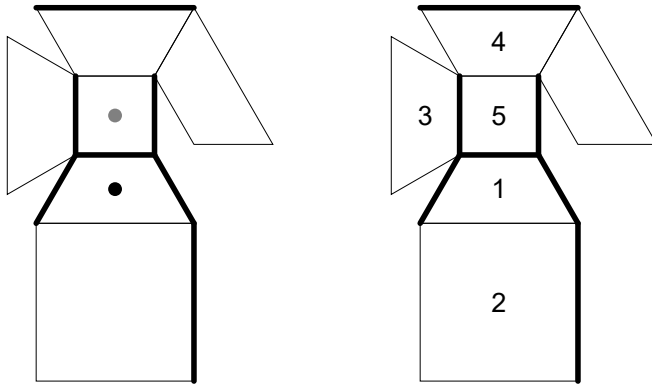

53

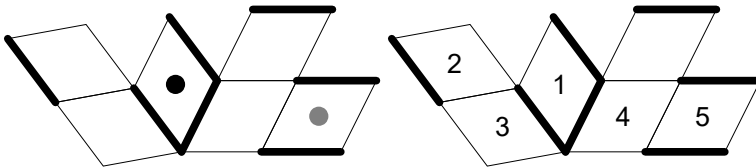

54

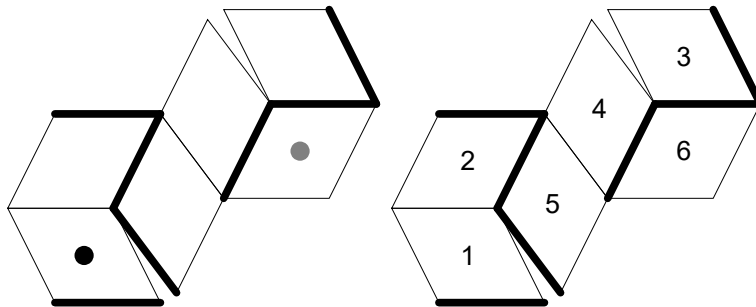

55

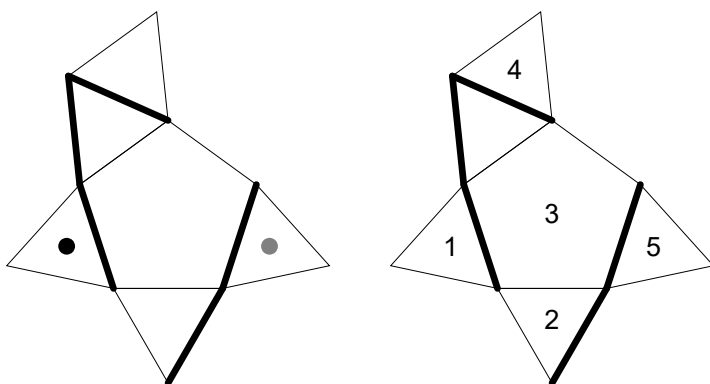

56

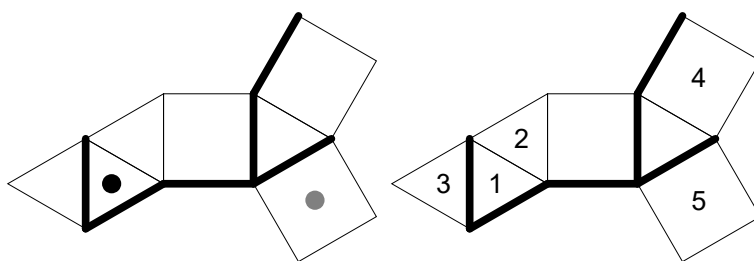

57

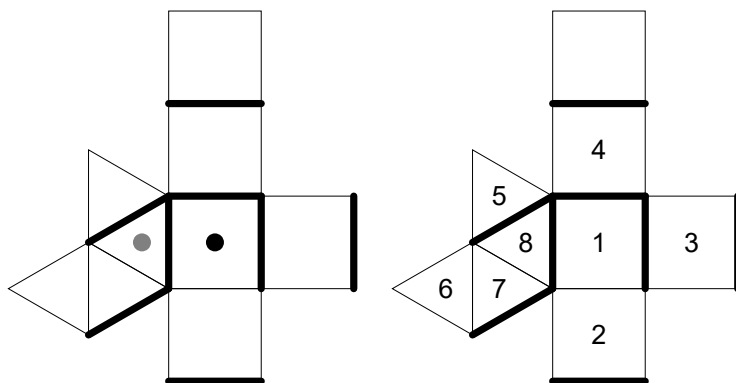

58

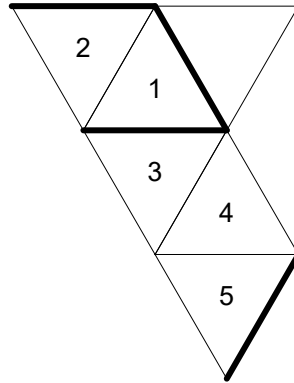
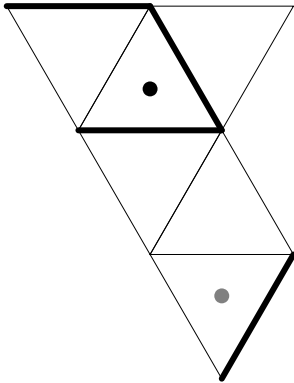

59

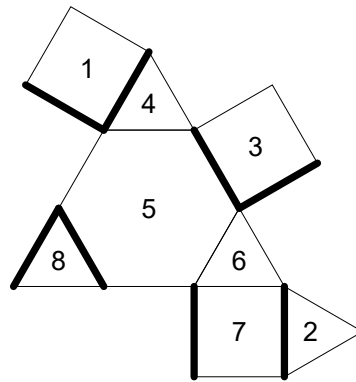
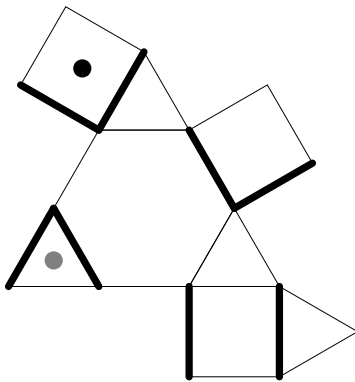

60

